

Adroit[®]

DV50 DV80 (Integral CO₂ Sensor)

Instruction Manual



Adroit® DV50 DV80 (Integral CO₂ Sensor)

Adroit® DV50 DV80 (Integral CO₂ Sensor)

CONTENTS

1. INTRODUCTION	4
<ul style="list-style-type: none"> • Main parts of the ventilation unit • System description • General safety instructions • Adroit digital controller • Starting up and shutting down the unit 	
2. DEPLOYMENT WIZARD	9
<ul style="list-style-type: none"> • Basic settings (setting the language, time and date) • Expert settings (setting the password and access rights, parental controls, fan settings, profile settings) 	
3. USING THE UNIT	20
<ul style="list-style-type: none"> • Ventilation profiles • Temperatures and sensors • Settings (filter, display settings, time and date, Week clock, turning the unit off) 	
4. MAINTENANCE	37
<ul style="list-style-type: none"> • Filters • Heat recovery cell • Fans • Condensing water • Troubleshooting 	
5. TECHNICAL SPECIFICATIONS	43
<ul style="list-style-type: none"> • Technical specifications, input powers, air volumes, sound values, fan curves, dimensions, duct outlets and measurement points • Internal electrical connection • External electrical connection 	
6. INSTALLATION	47
<ul style="list-style-type: none"> • Installation site and mounting • Measuring tubes • Dimensions and duct outlets • Condensing water outlet 	
7. EXPLODED VIEW AND PARTS LIST	50
8. USER LEVEL DIAGRAMS	51
9. CERTIFICATE OF CONFORMITY	53
10. COMMISSIONING THE SYSTEM	54
11. WARRANTY	54



NOTE:









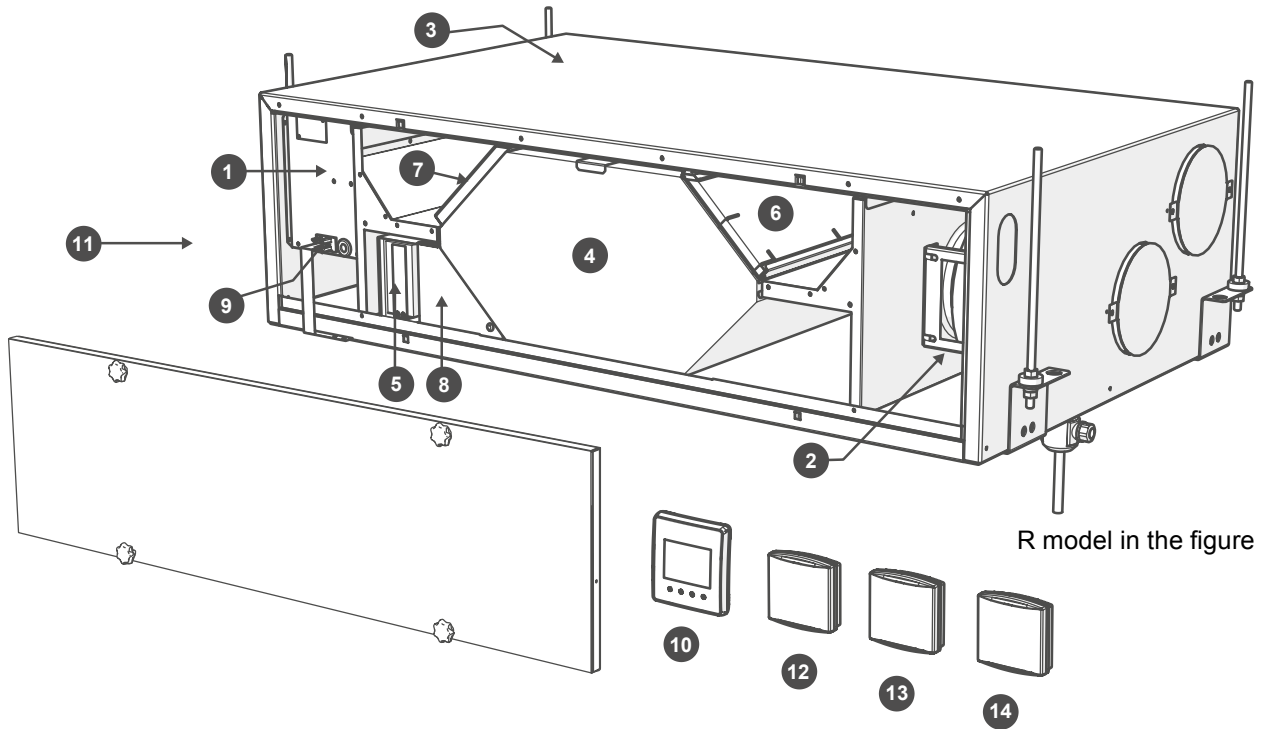





You can sign into your Adroit account at: www.airflowadroitcontrol.com

Adroit® DV50 DV80 (Integral CO₂ Sensor)

INTRODUCTION

MAIN PARTS OF THE VENTILATION UNIT



- | | | | | | |
|-------------------------------------------------------------------------------------|-------------------------------|---|-------------------------------------------------------------------------------------|----------------------------------|----|
|  | Supply air fan | 1 |  | Electrical safety cut off switch | 9 |
|  | Extract air fan | 2 |  | Digital Controller | 10 |
|  | Post-heating resistor | 3 |  | Internal humidity sensor | 11 |
|  | Heat recovery cell | 4 |  | Internal carbon dioxide sensor | 11 |
|  | Fine filter for supply air | 5 |  | Carbon dioxide sensor (optional) | 12 |
|  | Coarse filter for supply air | 6 |  | Humidity sensor (optional) | 13 |
|  | Coarse filter for extract air | 7 |  | VOC sensor (optional) | 14 |
|  | Bypass damper of the HR cell | 8 | | | |

 **NOTE** For more detailed instructions, go to www.airflow.com

Adroit® DV50 DV80 (Integral CO₂ Sensor)

INTRODUCTION

SYSTEM DESCRIPTION

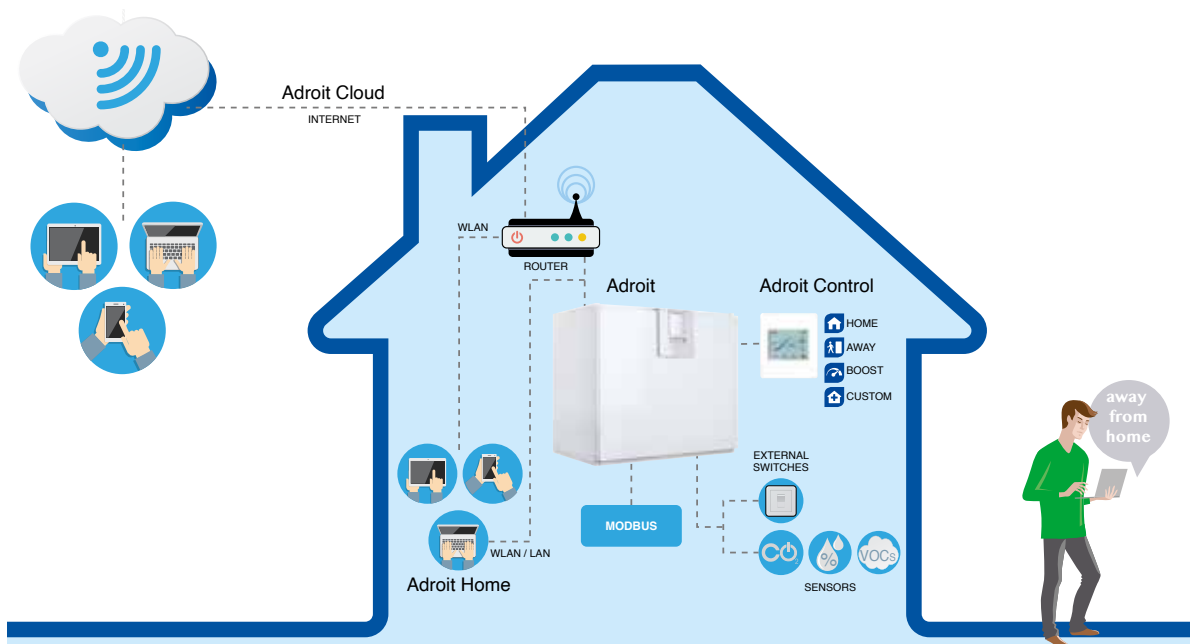

CONNECTING WITH ADROIT HOME

1. Connect Adroit unit to the mains.
2. Connect one end of the network cable (RJ-45) to computer and the other end to network connector on the Adroit unit.
3. Select on your computer: Start → Computer → Network
4. Double click on the Airflow icon.
5. Now you are connected to the Adroit Home service, you are able to control the Adroit unit.

REGISTERING TO THE ADROIT CLOUD

1. Connect with Adroit Home (instruction above).
2. Select Settings.
3. Press connect button in Adroit Cloud Service section.
4. Registration Page is now opened.
5. Enter the following information
 - a. Device name- enter the desired name for the device
 - b. User name
 - c. E-mail address
 - d. Password
6. Press the create account button.
7. An e-mail with your log-in details will be sent to the e-mail given during the registration process.
8. A verification e-mail will be sent to the e-mail address given during the registration process.
9. Click on the link given in this e-mail to verify your e-mail address.
10. You are now connected to the Adroit Cloud.



NOTE

The Adroit unit can also be connected by network cable to a router. In this case the Adroit unit can be controlled via your laptop, tablet, smartphone etc using a network created by the router.



NOTE

Following requirements:
 Firefox, version 31 or higher
 Opera, version 25 or higher
 Chrome, version 31 or higher
 Safari, version 7 or higher
 The latest browser versions on mobile devices.

Adroit[®] DV50 DV80 (Integral CO₂ Sensor)

INTRODUCTION

GENERAL SAFETY INSTRUCTIONS

For safe and proper handling, it is necessary to know the basic safety regulations and the intended usage of the ventilation system. Read this manual before operating the ventilation unit. Keep this manual for later use. In case of loss, you can download the manual from our website.

This user manual contains all important tips for operating the system safely. This user manual must be observed by all persons who operate and maintain the ventilation system. Furthermore, observe all local accident prevention regulations.

INTENDED USE

All Adroit ventilation units have been designed to provide appropriate and continuous ventilation in such a way that people and structures will remain healthy.

INSTALLATION

















Installation and setup should be carried out only by competent person. Electrical installations and connections must be carried out only by an electrician and in compliance with local regulations.

Adroit[®] DV50 DV80 (Integral CO₂ Sensor)

INTRODUCTION

ADROIT DIGITAL CONTROLLER

Note: Option description can be set by the button below the displayed image.

DISPLAYED IMAGE	OPTION DESCRIPTION
	Change profile. Allows you to scroll through the ventilation profiles.
	Profile Information. Allows you to view the currently active profile information.
	Temperature. Displays information on temperatures and sensors.
	Settings. Opens individual settings.
	Back. Takes you backwards in the menu.
	Left arrow. Allows you to scroll to the left through the menu settings.
	Right arrow. Allows you to scroll to the right through the menu settings.
	OK. Allows you to accept the selected option.
	Select. Allows you to select an option from the shown menu.
	Edit. Allows you to edit settings.
	Plus. Allows you to: Increase the value of the selected setting. Move to the next menu item. Move from a one-day view to a week view in the temperature, relative humidity of air and carbon dioxide level graphs.
	Minus. Allows you to: Reduce the value of the selected setting. Return to the previous menu item. Move from a week view to a one-day view in the temperature, relative humidity of air and carbon dioxide level graphs.
	Up arrow. Allows you to scroll upwards in the menu.
	Down arrow. Allows you to scroll downwards in the menu.
	Statistics. Allows you to open the temperature, relative humidity of air and carbon dioxide level graphs (1 day or 1 week).
	Indicate the chosen user level.
	Indicates when the feature is locked at your user level. The parental controls lock code is 1001.

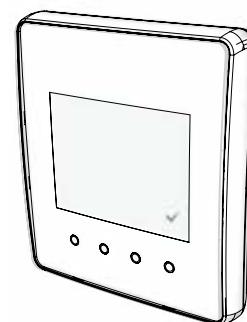

NOTE

The Adroit Digital Controller contains the buttons described in the following table. You can press the graphical user interface buttons by using the ring-shaped buttons below the controller. The controller does not have a touch screen.

Adroit® DV50 DV80 (Integral CO₂ Sensor)

INTRODUCTION

INTRODUCTION

Ventilation has to be constant for the indoor air to stay healthy for the dwellers and the structures of the dwelling. Even for longer holidays, it is not advisable to stop the ventilation, because the indoor air will become stuffy and during the heating season, the indoor air humidity may condense in the ventilation ductwork and structures, causing moisture damage.

You can control and automate the ventilation unit operation in the following ways:

- By using a controller installed in the building
- Through the Home local network connection and the Web interface
- Through the Adroit Cloud Service and the Web interface
- Through a remote monitoring service or building automation by using voltage signals or Modbus messages

The required ventilation may also be adjusted automatically with the optional carbon dioxide and humidity sensors. In this case, ventilation remains optimal even if the dwelling is unoccupied.

By using the Week clock you can create just the right ventilation for your individual lifestyle.

The following settings will be configured during the setup of the ventilation system:

- user interface language
- time and date
- system administrator password
- parental controls, if turned on
- fan settings
- user profile settings, such as the temperature.

The qualified ventilation installer must complete the fan settings in accordance with the ventilation plan. Do not change these settings.

STARTING THE UNIT

If you are starting the ventilation unit for the first time or after a maintenance procedure, first connect it to the mains. During the start-up, the diagnostics display will appear for a few seconds, after which the main display of the At home profile opens.

If the ventilation unit was turned off from the controller (see Turning the Unit Off), you can start it by pressing any controller's button.

Updating the unit software

Disconnect the ventilation unit from the mains electrical supply or turn off the fuse.

Connect the computer to the digital controller of the ventilation unit using a USB MicroB connector.

Start the ventilation unit. A USB sign will appear on the display of the controller. The controller cannot be used when it is connected to the computer.

Transfer the update file you have downloaded onto the ventilation unit. Copy the update file HSWUPD.



WARNING

The unit is not intended for use by children under 8 or by persons with reduced sensory, physical or mental capabilities or whose lack of knowledge and experience do not ensure safe operation of the unit.

Such persons can use the unit under supervision or by following the instructions of someone who is responsible for their safety.

SWITCHING THE UNIT OFF

If you want to switch off the ventilation unit, proceed as follows:

1. Select **Settings** > Turn unit **OFF**.
2. Press the **OK** button.
3. The system asks for confirmation.
4. Press the **OK** button.
5. The ventilation unit is now switched **OFF**.



TIP

The Adroit Digital Controller automatically switches to the sleep mode when the Sleep time set in the Display settings has elapsed. You can wake up the controller by pressing any controller's button.



NOTE

The first starting of the unit may take a while because of the software version check.

(Please note! Do not alter the file name!) you have downloaded at the root of the controller (the controller will be displayed on your computer as a mass memory or a removable disk drive). When the file has uploaded onto the controller, remove the USB cable. Next, the controller will take a while to load the update. The controller will now start to load the update file onto the motherboard. This can take several hours. The controller will remain turned on, but it is recommended that the controller will not be used during that time. When the update is ready, the unit will restart automatically.

Adroit® DV50 DV80 (Integral CO₂ Sensor)

DEPLOYMENT WIZARD

1. Start the Adroit ventilation unit.
2. Press the **OK** button.
3. The deployment wizard is launched.

SELECTING THE LANGUAGE

Select the user interface language as follows:

1. Use the arrow buttons to select the language.
2. Select **OK**.
3. The language has now been set and the controller will move on to the time settings.



SET THE TIME

When the deployment wizard prompts you to set the date and time, the Time and date screen is opened first:

1. Use the **Plus** and **Minus** buttons to set the hours.
2. Press the **Right arrow** button.
3. Use the **Plus** and **Minus** buttons to set the minutes.
4. The time is now set.
5. Proceed to the next phase by pressing the **Right arrow** button.

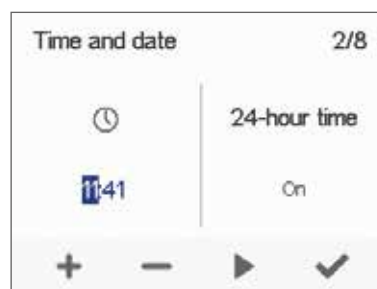

SET THE 24- OR 12-HOUR CLOCK

By default, the system uses the **24** hour clock.

If you want to use the **24** hour clock, proceed to the next step by pressing the **Right arrow** button.

If you want to use the **12** hour clock, proceed as follows:

1. Press the **Minus** button. The **24 Hour Time** setting value is changed to **Off**.
2. Proceed to the next phase by pressing the **Right arrow** button.

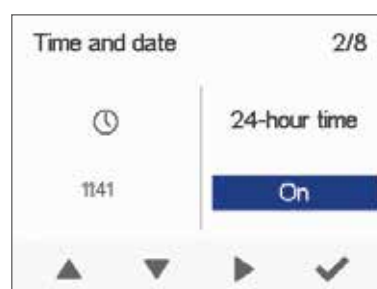

Adroit® DV50 DV80 (Integral CO₂ Sensor)

BASIC SETTINGS

SET THE AUTOMATIC DAYLIGHT SAVING TIME

By default, the system automatically switches to the summer time. If you want to use the automatic daylight saving time, proceed to the next step by pressing the Right arrow button. If you want to use the manual daylight saving time, proceed as follows:

1. Press the **Minus** button. The Daylight saving time setting value is changed to **Off**.
2. The manual daylight saving time setting is now set.
3. Proceed to the next phase by pressing the **Right arrow** button.

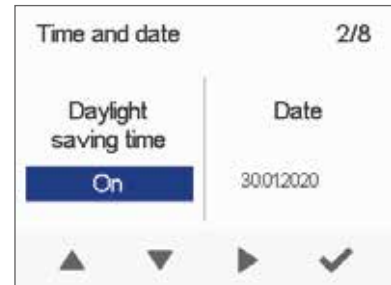

SET THE DATE

1. Use the **Plus** and **Minus** buttons to set the date.
2. Press the **Right arrow** button.
3. Use the **Plus** and **Minus** buttons to set the month.
4. Press the **Right arrow** button.
5. Use the **Plus** and **Minus** buttons to set the year.
6. Press the **OK** button:
7. The date is now set.

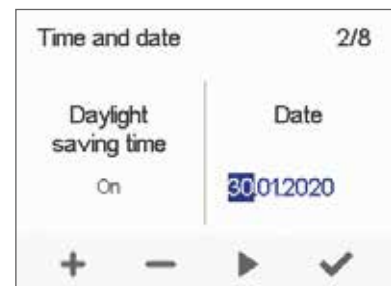

FINISHING UP THE DEPLOYMENT

When the basic settings have been completed, the acknowledgement screen is opened.

If you want to continue and make the advanced settings for the ventilation unit, press the **OK** button.

If you do not wish to proceed with the advanced settings and use the ventilation device on factory settings, press the **Back** button: Expert settings for the ventilation device can be installed at a later date when required.

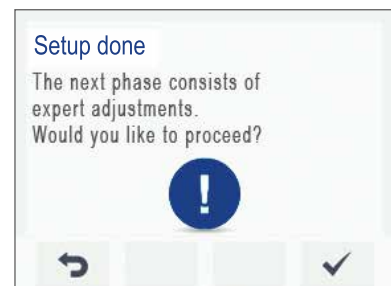

EXPERT SETTINGS

The following sections describe the ventilation device deployment wizard phase, where you activate the expert settings.

! IMPORTANT

Some deployment phases require special equipment, such as an air flow meter.

Adroit® DV50 DV80 (Integral CO₂ Sensor)

EXPERT SETTINGS

PASSWORD AND ACCESS LEVEL

Once you have finished up the basic settings, the deployment wizard moves on to setting the system password.



NOTE

If you set the password as 0000, the password inquiry is not used.

1. The deployment wizard Password and access level screen is opened.
2. Set the first digit of the password by using the **Up arrow** and **Down arrow** buttons. Proceed to the next digit by pressing the **Right arrow** button.
3. Set the second, third and fourth digit in the same manner as the first digit.
4. Press the **OK** button.
5. The password is now set.



ENTER THE NEW PASSWORD HERE:



USER LEVEL

There are three user levels:

- **Extensive** — At the extensive user level, the user can access every menu on the controller.
- **Normal** — At the normal user level, the user's access to some menus is restricted.
- **Limited** — At the limited user level, the user has access only to the basic functions of the ventilation units.

For more information on user levels, see section 9, User level diagrams. If you want to set the system user level, proceed as follows:

1. The deployment wizard User level screen is opened.
2. Use the **Plus** and **Minus** buttons to set the user level.
3. Press the **Right arrow** button.
4. The user level is now set.

PARENTAL CONTROLS

Parental control locks the digital controller, protecting the units settings. If you want to set the system child lock, proceed as follows:

1. The deployment wizard Password and access level screen is opened.
2. Set the parental controls on or off by using the **Plus** and **Minus** buttons.
3. Press the **OK** button.
4. The parental controls are now set.



PARENTAL CONTROLS ACCESS CODE:

1 0 0 1

Adroit® DV50 DV80 (Integral CO₂ Sensor)

EXPERT SETTINGS

FAN SETTINGS

The following sections describe how to set the output ratio between the supply and extract air fans.



IMPORTANT

Adjust the air flows according to the values in the ventilation design. Try to adjust the air flows in a way that you do not have to choke the air flows at the valves. This is the most energy efficient set up.

First, set both supply and extract values as close to the ideal value as possible. The ideal values are presented in the supply and extract air volume graphs. If, at the beginning, the air flows differ greatly from the designed rate, check the air flows by measuring them at the valves and adjust the airflow rates if necessary by first adjusting the units fans, then by adjusting the room valves.



NOTE

If the outside air is extremely cold (below -3°C on a plastic cell), the ventilation device may have to defrost the heat exchanger cell. If this occurs, you cannot adjust the air flows and the **Defrosting** figure is shown on the controller.

SUPPLY AIR

If you want to set the system supply air settings, proceed as follows:

1. The deployment wizard Fan settings screen is opened.
2. Set the supply air quantity as a percentage of the maximum output ratio by using the **Plus** and **Minus** buttons. The fan speed (1/min) will change, according to the percentage value.
3. Once you have set the supply air fan settings, press the **Right arrow** button.

EXTRACT AIR

If you want to set the system extract air settings, proceed as follows:

1. The deployment wizard Fan settings screen is opened.
2. Set the extract air quantity as a percentage of the maximum output ratio by using the **Plus** and **Minus** buttons. The fan speed (1/min) will change, according to the percentage value.
3. Press the **OK** button.
4. The extract air fan speed is now set.



WARNING

The ventilation specialist has set the supply and exhaust air settings when deploying the ventilation unit. If you make changes to the settings, ensure that they conform with the ventilation design to ensure the system still complies with Building Regulations.

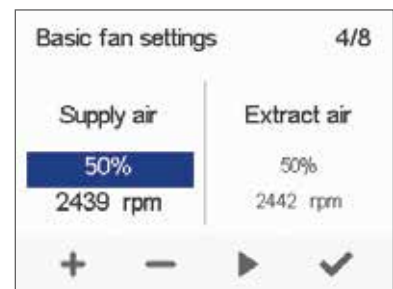
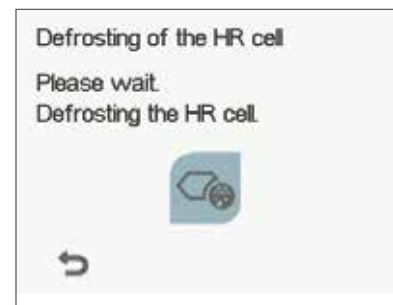

Adroit[®] DV50 DV80 (Integral CO₂ Sensor)

EXPERT SETTINGS

PROFILE SETTINGS

In the following sections you can make ventilation settings for the system profiles.

AT HOME PROFILE

If you want to set the **At home** profile settings, proceed as follows:

1. The deployment wizard **At home** screen will open.



NOTE

When the units fans have been set (step 5 in the deployment wizard) these values will default to the **At home** profile fan speed value. We recommend this basic amount of ventilation for the **At home** profile setting. If necessary, you can change it.

2. Set the **At Home** profile fan speed as a percentage of the maximum output ratio by using the **Plus** and **Minus** buttons.
3. The **At Home** profile fan speed value is now set.
4. Press the **Right arrow** button.
5. The temperature setup screen is opened.
6. Set the desired supply air temperature for the **At Home** profile by using the **Plus** and **Minus** buttons. You can adjust the temperature in the range of +10°C – +5°C.
7. The **At home** profile supply air temperature is now set.
8. Press the **Right arrow** button.
9. The setup screen for the automatic fan speed control, based on the relative humidity, appears.
10. Use the **Plus** and **Minus** buttons to select whether the automatic fan speed control, based on the relative humidity, is used or not.
11. The automatic fan speed control, based on the relative humidity, is now set.
12. Press the **Right arrow** button.
13. The setup screen for the automatic fan speed control, based on the carbon dioxide or VOC content, appears.
14. Use the **Plus** and **Minus** buttons to select whether the automatic fan speed control, based on the carbon dioxide or VOC content, is used or not.
15. The automatic fan speed control, based on the carbon dioxide or VOC content, is now set.
16. Press the **OK** button.

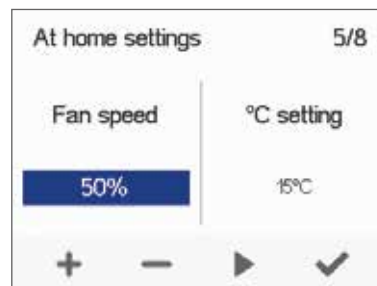

NOTE

You can browse the settings of the **At home** profile with the **Right arrow** button.

Adroit® DV50 DV80 (Integral CO₂ Sensor)

EXPERT SETTINGS

AWAY PROFILE

If you want to set the **Away** profile settings, proceed as follows:

1. The deployment wizard **Away** profile screen is opened.



NOTE

Once you have set the fan speed for the **At home** profile, the fan speed for the **Away** profile will default to -30% of the **At home** profile fan speed. We recommend this basic amount of ventilation for the **Away** profile setting. If necessary, you can change it.

2. Set the **Away** profile fan speed as a percentage of the maximum output ratio by using the **Plus** and **Minus** buttons.
3. The **Away** profile fan speed value is now set.
4. Press the **Right arrow** button.
5. The temperature setup screen is opened.
6. Set the desired supply air temperature for the **Away** profile by using the **Plus** and **Minus** buttons. You can adjust the temperature in the range of +10°C – +5°C.
7. The **Away** profile supply air temperature is now set.
8. Press the **Right arrow** button.
9. The setup screen for automatic fan speed control, based on the relative humidity, appears.
10. Use the **Plus** and **Minus** buttons to select whether the automatic fan speed control, based on the relative humidity, is used or not.
11. The automatic fan speed control, based on the relative humidity, is now set.
12. Press the **Right arrow** button.
13. The setup screen for the automatic fan speed control, based on the carbon dioxide or VOC content, appears.
14. Use the **Plus** and **Minus** buttons to select whether the automatic fan speed control, based on the carbon dioxide or VOC content, is used or not.
15. The automatic fan speed control, based on the carbon dioxide or VOC content, is now set.
16. Press the **OK** button.



Adroit[®] DV50 DV80 (Integral CO₂ Sensor)

EXPERT SETTINGS

BOOST PROFILE

If you want to set the **Boost** profile settings, proceed as follows:

1. The deployment wizard **Boost** profile screen is opened.



NOTE

Once you have set the fan speed for the **At home** profile, the fan speed for the **Boost** profile will default to +30% of the At home profile fan speed. We recommend this basic amount of ventilation for the **Boost** profile setting. If necessary, you can change it.

2. Set the **Boost** profile fan speed as a percentage of the maximum output ratio by using the **Plus** and **Minus** buttons.
3. Press the **Right arrow** button.
4. The temperature setup screen is opened.
5. Set the desired supply air temperature for the **Boost** profile by using the **Plus** and **Minus** buttons. You can adjust the temperature in the range of +10°C – +5°C.
6. Press the **Right arrow** button.
7. The setup screen for the automatic fan speed control, based on the relative humidity, appears.
8. Use the **Plus** and **Minus** buttons to select whether the automatic fan speed control, based on the relative humidity, is used or not.
9. Press the **Right arrow** button.
10. The setup screen for the automatic fan speed control, based on the carbon dioxide or VOC content, appears.
11. Use the **Plus** and **Minus** buttons to select whether the automatic fan speed control, based on the carbon dioxide or VOC content, is used or not.
12. Press the **Right arrow** button.
13. The profile timer setting screen is displayed.
14. Use the **Plus** and **Minus** buttons to select whether the profile timer function is enabled or not. The options are:
 - **On** — When the timer is enabled, the **Boost** profile is only on for the period defined in the timer.
 - **Off** — When the timer is disabled, the **Boost** profile is used until you (or the Week clock) change the profile.
15. Press the **Right arrow** button.
16. The timer duration setting screen appears.
17. Set the profile timer duration in minutes by using the **Plus** and **Minus** buttons.
18. Press the **OK** button.

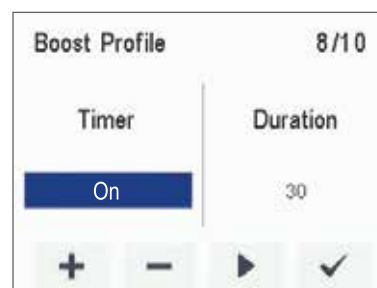

Adroit® DV50 DV80 (Integral CO₂ Sensor)

EXPERT SETTINGS

CUSTOM PROFILE

If you want to set the **Custom** function settings, proceed as follows:

1. The deployment wizard **Custom** function profile screen is opened.
2. Set the profile timer duration in minutes by using the **Plus** and **Minus** buttons.
3. The profile duration is now set.
4. Press the **Right arrow** button.
5. The screen for setting the profile supply air fan speed appears.
6. Set the **Custom** function supply air fan speed as a percentage of the maximum output ratio by using the **Plus** and **Minus** buttons.

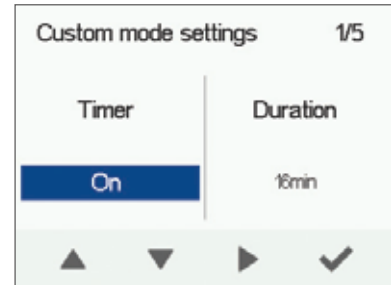

TIP

In the Custom mode, we recommend that you increase the supply air fan speed in order to obtain a positive pressure at the ventilation zone. We do not recommend reducing the extract air fan speed.

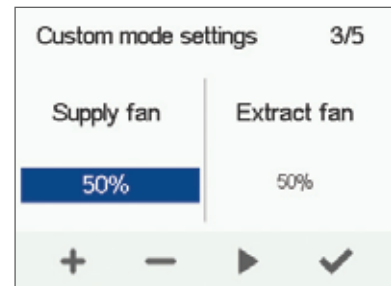

7. The **Custom function** supply air fan speed is now set.
8. Press the **Right arrow** button.
9. The screen for setting the profile extract air fan speed appears.
10. Set the **Custom function** extract air fan speed as a percentage of the maximum output ratio by using the **Plus** and **Minus** buttons.

11. The **Custom function** extract air fan speed is now set.
12. Press the **Right arrow** button.
13. The profile timer setting screen is displayed.
14. Use the **Plus** and **Minus** buttons to select whether the profile timer function is enabled or not. The options are:
 - **On** — When the timer is enabled, the **Custom function** is only on for the period defined in the timer.
 - **Off** — When the timer is disabled, the **Custom function** is used until you (or the Week clock) change the profile.
15. The profile timer function is now set.
16. Press the **OK** button.
17. The **Custom function** settings are now complete.

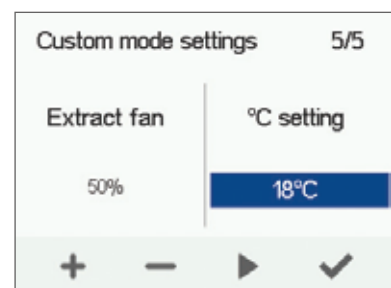

Adroit® DV50 DV80 (Integral CO₂ Sensor)

VENTILATION PROFILES

FINISHING UP

When you have completed the wizard, the Setup done screen will open.

Finish up the deployment as follows:

1. If you want to go back to repair or change a value, use the arrow buttons to select the desired line and press the **OK** button.
2. Repeat the selected setup phase or phases until you are satisfied with the settings.
3. When you are satisfied with the settings, use the arrow buttons to select Start and press the **OK** button.

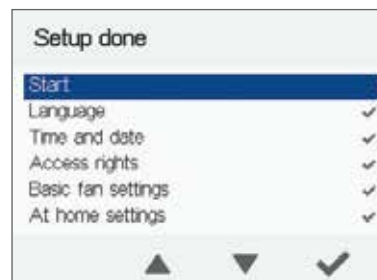

Adroit® DV50 DV80 (Integral CO₂ Sensor)

VENTILATION PROFILES

THE VENTILATION UNIT HAS FOUR VENTILATION PROFILES:



AT HOME

Use this ventilation profile when the dwelling or the premises are occupied



AWAY

Use this ventilation profile when the dwelling or premises are unoccupied, e.g. during a trip or other long absence.



BOOST

Use this profile to increase the ventilation rate, e.g. when there are more people than usual in the dwelling or local ventilation regulations dictate.



CUSTOM

Use this ventilation profile when, for example, you are making a fire in the fireplace. This profile is primarily used to create momentary overpressure in the dwelling to help elevate back spillage into the room.

SYMBOLS FOR VENTILATION PROFILES

The following symbols are used on the main displays of the profiles:
Table 2. Profile symbols

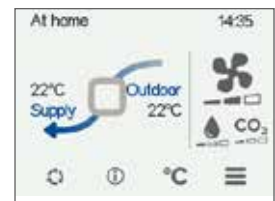

SYMBOL	DESCRIPTION
	The mode in use is either At home, Away, or Boost. The Week clock is turned off.
	The mode in use is either At home, Away, or Boost. The Week clock is on.
	The mode in use is Custom. The Week clock might be turned on.
	The mode in use is either At home, Away, or Boost. The programmable input has become activated.
	These fan symbols indicate the currently used mode. <ul style="list-style-type: none"> Fan and one shaded bar — The Away mode is in use. Fan and two shaded bars — The At home mode is in use. Fan and three shaded bars — The Boost mode is in use.
	Droplet symbols indicate the relative humidity of air. <ul style="list-style-type: none"> Droplet and one shaded bar — A humidity sensor has been installed and the relative humidity of air is normal. Droplet and two shaded bars — The relative humidity of air is slightly higher than normal. Ventilation efficiency needs to be boosted. When the automatic fan speed control is based on the relative humidity of the air, ventilation is automatically boosted. Droplet and three shaded bars — The relative humidity of air is significantly higher than normal. The fan speed will be automatically increased if automatic adjustment has been chosen.
	CO ₂ symbols indicate the carbon dioxide or the VOC level in the air. <ul style="list-style-type: none"> CO₂ and one shaded bar - The carbon dioxide or VOC sensor has been installed and the level is normal. CO₂ and two shaded bars - The carbon dioxide or VOC level is slightly higher than normal. The fan speed will be automatically increased if automatic adjustment has been chosen. CO₂ and three shaded bars - The carbon dioxide or VOC level is significantly higher than normal. The fan speed will be automatically increased if automatic adjustment has been chosen.

Adroit® DV50 DV80 (Integral CO₂ Sensor)

VENTILATION PROFILES

CHANGING THE PROFILE

If you want to change the ventilation profile, proceed as follows:

1. Press the **Change profile** button until the desired ventilation profile icon appears on the display.
2. Wait until the main display of the ventilation profile appears.
3. The ventilation profile will now be changed.

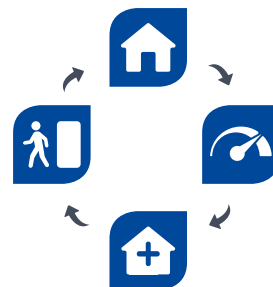

VIEWING VENTILATION PROFILE INFORMATION

VIEWING THE AT HOME PROFILE INFORMATION

If you want to view the **At home** profile settings, proceed as follows:

1. Open the **At home** profile main view.
2. Press the **Profile information** button.
3. The first information screen for the profile appears.

This screen contains the following information:

- **Supply air** — Indicates the temperature of the air blown into the property and its set value shown in brackets, if the supply air is warmer than the set value.
 - **Outdoor air** — Indicates the outdoor air temperature.
 - **Fan speed** — Indicates the fan speed. If the automatic fan speed **boost** is turned on, the set value is shown in brackets first followed by the actual fan speed.
 - **Heat recovery cell status** — Indicates the status of the ventilation unit heat recovery cell. The status options are:
 - **Heat recovery** — The heat recovery cell heats the air streaming in from outdoors.
 - **Cooling** — The heat recovery cell cools the air streaming in from outdoors.
 - **Cell bypass** — The inflowing air bypasses the heat recovery cell.
 - **Defrosting** — The heat recovery cell is being defrosted.
4. Press the **Right arrow** button.
 5. The second information screen for the profile appears.

This screen contains the following information:

- **Humidity** — Indicates the highest relative humidity of air measured by the extract air sensor.
- **Carbon dioxide** — Indicates the highest carbon dioxide level measured by the extract air sensor.
- **Change filters** — Indicates the next recommended filter change date.
- **Days in use** — Indicates how long the unit has been running in days and years.

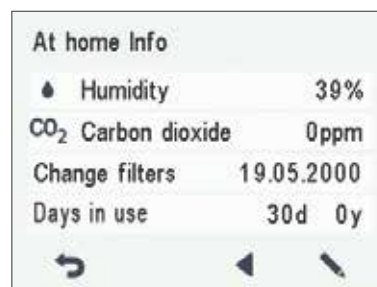
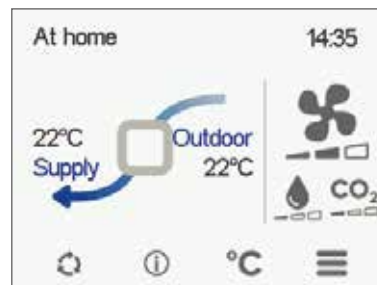

Adroit® DV50 DV80 (Integral CO₂ Sensor)

VENTILATION PROFILES

VIEWING THE AWAY PROFILE INFORMATION

If you want to view the Away profile settings, proceed as follows:

1. Open the **Away** profile main view.
2. Press the **Profile information** button.
3. The first information screen for the profile appears.

This screen contains the following information:

- **Supply air** — Indicates the temperature of the air blown in to the property and its set value shown in brackets, if the supply air is warmer than the set value.
- **Outdoor air** — Indicates the outdoor air temperature.
- **Fan speed** — Indicates the fan speed. If the automatic fan speed **boost** is turned on, the set value is shown in brackets first followed by the actual fan speed.
- **Heat recovery cell status** — Indicates the status of the ventilation unit heat recovery cell. Possible statuses are:
 - **Heat recovery** — The heat recovery cell heats the air streaming in from outdoors.
 - **Cooling** — The heat recovery cell cools the air streaming in from outdoors.
 - **Cell bypass** — The inflowing air by-passes the heat recovery cell.
 - **Defrosting** — The heat recovery cell is being defrosted.

4. Press the **Right arrow** button.
5. The second information display for the profile opens.

This screen contains the following information:

- **Humidity** — Indicates the highest relative humidity of air measured by the extract air sensor.
- **Carbon dioxide** — Indicates the highest carbon dioxide level measured by the extract air sensor.
- **Change filters** — Indicates the next recommended filter change date.
- **Days in use** — Indicates how long the unit has been running in days and years..

Away info	
Supply air	(15°C) 20°C
Outdoor air	7°C
Fan speed	(30%) 50%
Cell status	Heat recovery

Away info	
Humidity	38%
CO ₂ Carbon dioxide	0ppm
Change filters	19.05.2000
Days in use	30d 0y

Adroit® DV50 DV80 (Integral CO₂ Sensor)

TEMPERATURES AND SENSORS

VIEWING THE BOOST PROFILE INFORMATION

To view the **Boost profile** settings, proceed as follows:

1. Open the **Boost** profile main view.
2. Press the **Profile information** button.
3. The first information screen for the profile is opened.

This screen contains the following information:

- **Supply air** — Indicates the temperature of the air blown in to the property and its set value shown in brackets, if the supply air is warmer than the set value.
 - **Outdoor air** — Indicates the outdoor air temperature.
 - **Fan speed** — Indicates the fan speed. If the automatic fan speed **boost** is turned on, the set value is shown in brackets first followed by the actual fan speed.
 - **Heat recovery cell status** — Indicates the status of the ventilation unit heat recovery cell. Possible statuses are:
 - **Heat recovery** — The heat recovery cell heats the air streaming in from outdoors.
 - **Cooling** — The heat recovery cell cools the air streaming in from outdoors.
 - **Cell bypass** — The inflowing air bypasses the heat recovery cell.
 - **Defrosting** — The heat recovery cell is being defrosted.
4. Press the **Right arrow** button.
 5. The second information display for the profile opens.

This display shows the following information:

- **Humidity** — Indicates the highest relative humidity of air measured by the extract air sensor.
- **Carbon dioxide** — Indicates the highest carbon dioxide level measured by the extract air sensor.
- **Change filters** — Indicates the next recommended filter change date.
- **Days in use** — Indicates how long the unit has been running in days and years.

Boost info	
Supply air	(15°C) 21°C
Outdoor air	8°C
Fan speed	30%
Cell status	Heat recovery

Boost info	
Humidity	37%
CO ₂ Carbon dioxide	0ppm
Change filters	19.05.2000
Days in use	30d 0y

VIEWING THE CUSTOM PROFILE INFORMATION

If you want to view the Custom function settings, proceed as follows:

1. Open the **Custom function** main view.
2. The profile main screen contains a summary of the profile data. Also see Table 2, "Profile symbols."

Adroit® DV50 DV80 (Integral CO₂ Sensor)

SETTINGS

1. Press the **Profile information** button.
2. The first information screen for the profile opens. This screen shows the following information:
 - **Duration** — Indicates the duration of enhanced ventilation when the **Custom profile** is activated. The value is shown in hours and minutes.
 - **Remaining** — Indicates the remaining duration of the Custom profile.
 - **Supply fan speed** — Indicates the percentage of the supply air fan speed relative to the maximum speed.
 - **Extract fan speed** — Indicates the percentage of the extract air fan speed relative to the maximum speed.

Custom mode info	1/2
Duration	15min
Remaining	15min
Supply air fan	50%
Extract air fan	50%

MODIFYING THE PROFILE SETTINGS

! IMPORTANT

The system uses, but does not save the settings automatically. Your settings may be lost during, for example, a power cut. Remember to save your settings by selecting Expert settings > Save and restore settings.

MODIFYING THE AT HOME PROFILE SETTINGS

1. Open the **At home** profile main view.
2. Press the **Profile information** button.
3. Press the **Edit** button.
4. The fan speed setup screen is opened.
5. Set the **At home** profile fan speed as a percentage of the maximum output ratio by using the **Plus** and **Minus** buttons.
6. Press the **Right arrow** button.
7. The temperature setup screen is opened.
8. Set the desired supply air temperature for the **At home** profile by using the **Plus** and **Minus** buttons. You can adjust the temperature in the range +10°C ... +5°C. The recommended temperature is +15°C or 2—3°C below the room temperature.
9. Press the **Right arrow** button.
10. The setup screen for the automatic fan speed control, based on the relative humidity, appears.
11. Use the **Plus** and **Minus** buttons to select whether the automatic fan speed control, based on the relative humidity, is used or not.
12. Press the **Right arrow** button.
13. The setup for automatic fan speed control based on the carbon dioxide or VOC level opens.
14. Use the **Plus** and **Minus** buttons to select whether the automatic fan speed control, based on the carbon dioxide or VOC level, is used or not.
15. Press the **OK** button.

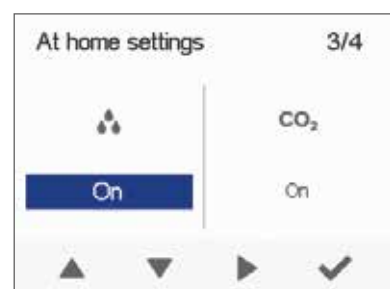
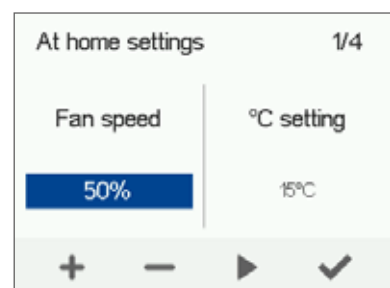

Adroit[®] DV50 DV80 (Integral CO₂ Sensor)

SETTINGS

MODIFYING THE AWAY PROFILE SETTINGS



1. Open the **Away** profile main view.
2. Press the **Profile information** button.
3. Press the **Edit** button.
4. The fan speed setup opens.
5. Set the **Away** profile fan speed as a percentage of the maximum output ratio by using the **Plus** and **Minus** buttons.
6. Press the **Right arrow** button.
7. The temperature setup screen is opened.
8. Set the desired supply air temperature for the **Away** profile by using the **Plus** and **Minus** buttons. You can adjust the temperature in the range +10°C ... +5°C. The recommended temperature is +15°C or 2—3°C below the room temperature.
9. Press the **Right arrow** button.
10. The setup screen for automatic fan speed control, based on the relative humidity, appears.
11. Use the **Plus** and **Minus** buttons to select whether the automatic fan speed control, based on the relative humidity, is used or not.
12. Press the **Right arrow** button.
13. The setup for automatic fan speed control based on the carbon dioxide or VOC level opens.
14. Use the **Plus** and **Minus** buttons to select whether the automatic fan speed control, based on the carbon dioxide or VOC level, is used or not.
15. Press the **OK** button.

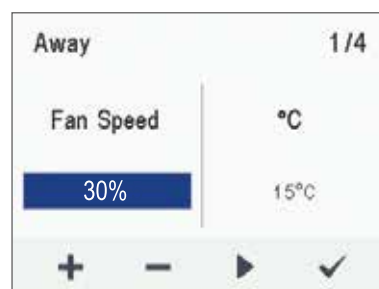

Adroit® DV50 DV80 (Integral CO₂ Sensor)

VENTILATION PROFILES

MODIFYING THE BOOST PROFILE SETTINGS

If you want to edit the Boost profile settings, proceed as follows:



1. Open **Boost** profile main view.
2. Press the **Profile information** button.
3. Press the **Edit** button.
4. The fan speed setup opens.
5. Set the Boost profile fan speed as a percentage of the maximum output ratio by using the **Plus** and **Minus** buttons.
6. Press the **Right arrow** button.
7. The temperature setup screen is opened.
8. Set the desired supply air temperature for the **Boost** profile by using the **Plus** and **Minus** buttons. The recommended temperature is +15°C or 2—3°C below the room temperature. You can adjust the temperature in the range of +10°C – +5°C.
9. Press the **Right arrow** button.
10. The setup screen for the automatic fan speed control, based on the relative humidity, appears.
11. Use the **Plus** and **Minus** buttons to select whether the automatic fan speed control, based on the relative humidity, is used or not.
12. Press the **Right arrow** button.
13. The setup for automatic fan speed control based on the carbon dioxide or VOC level opens.
14. Use the **Plus** and **Minus** buttons to select whether the automatic fan speed control, based on the carbon dioxide or VOC level, is used or not.
15. Press the **Right arrow** button.
16. The profile timer setting screen is opened.
17. Use the **Plus** and **Minus** buttons to select whether the profile timer function is used or not. The options are:
 - **On** — When the timer is on, the **Boost** profile is used only for the period specified in the timer.
 - **Off** — When the timer is off, the **Boost** profile is used until manually changed (or the Week clock) or the profile is changed.
18. Press the **Right arrow** button.
19. The profile timer duration setting screen is opened.
20. Set the profile timer duration by using the **Plus** and **Minus** buttons.
21. Press the **OK** button.

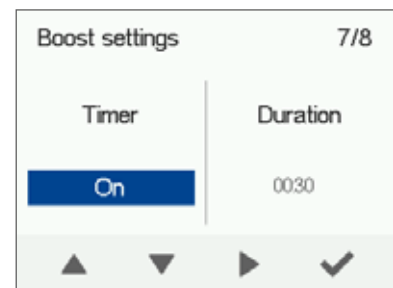
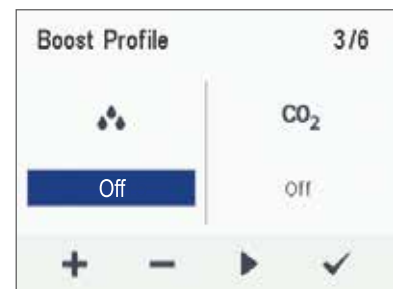
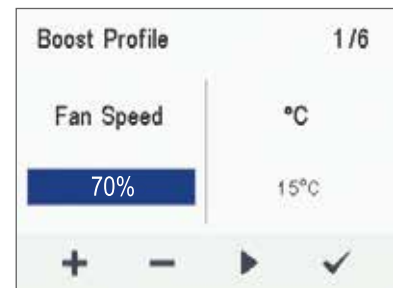

Adroit® DV50 DV80 (Integral CO₂ Sensor)

VENTILATION PROFILES

MODIFYING THE CUSTOM PROFILE SETTINGS

If you want to edit the Custom function settings, proceed as follows:

1. Open the **Custom function** main view.
2. Press the **Profile information** button.
3. Press the **Edit** button.
4. The fan speed setup screen is opened.
5. Use the **Plus** and **Minus** buttons to set the **Custom function** duration in minutes. This value determines how long the profile is enabled when you switch it on.
6. Press the **Right arrow** button.
7. The screen for setting the profile supply air fan speed appears.
8. Set the **Custom function** supply air fan speed as a percentage of the maximum output ratio by using the **Plus** and **Minus** buttons.

i TIP

In the Custom mode, we recommend that you increase the supply air fan speed, in order to obtain a positive pressure at the ventilation zone. We do not recommend reducing the extract air fan speed.

9. Press the **Right arrow** button.
10. The screen for setting the profile extract air fan speed will appear.
11. Set the **Custom function** extract air fan speed as a percentage of the maximum output ratio by using the **Plus** and **Minus** buttons.
12. Press the **Right arrow** button.
13. The profile timer setting screen is displayed.
14. Use the **Plus** and **Minus** buttons to select whether the profile timer function is enabled or not. The options are:
 - **On** — When the timer is enabled, the **Custom function** is only on for the period defined in the timer.
 - **Off** — When the timer is disabled, the **Custom function** is used until manually changed (or the Week clock) or the profile is changed.
15. Press the **OK** button.

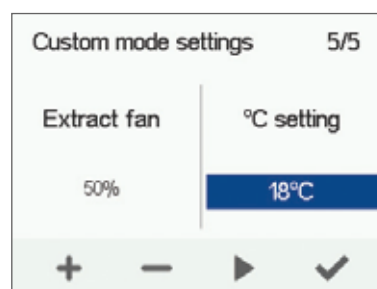
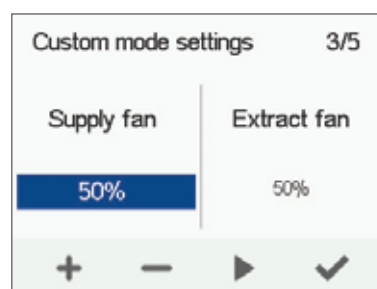
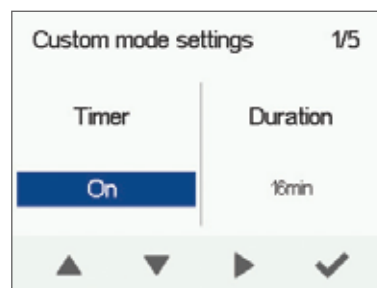

Adroit® DV50 DV80 (Integral CO₂ Sensor)

TEMPERATURES AND SENSORS

VIEWING TEMPERATURE DATA

If you want to view the system temperature and sensor data, proceed as follows:

1. Select **Settings > Temperatures and sensors**.
2. Press the **OK** button.
3. The temperature and sensors summary screen is opened.

This screen contains the following information:

- **Indoor** — Indicates the temperature of the air flowing into the unit to be removed from the property.
- **Outdoor** — Indicates the temperature of the air flowing into the unit from outdoors.
- **Supply** — Indicates the temperature of the air flowing into the property from the unit.
- **Exhaust** — Indicates the temperature of the exhaust air flowing outdoors from the unit.

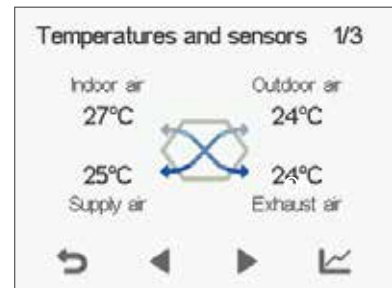

i TIP

The temperature and sensor data can also be viewed by pressing the temperature button on the profile display.

VIEWING TEMPERATURE STATISTICS

If you want to view the system temperature statistics, proceed as follows:

1. Select **Settings > Temperatures and sensors**.
2. Press the **OK** button.
3. The temperatures summary screen is opened.
4. Press the **Statistics** button.
5. A graph is opened, describing the indoor air temperature over the last 24 hours.
6. To view weekly statistics, press the **Plus** button.
7. A graph is opened, describing the indoor air temperature over the last seven days.
8. You can return to daily statistics by pressing the **Minus** button.
9. You can return to the temperature type selection by pressing the **Back** button.
10. Press the **Right arrow** button.
11. A graph is opened, describing the outdoor air temperature over the last 24 hours.
12. If you want to view weekly statistics, press the **Plus** button.
13. A graph then opens showing the outdoor air temperature over the last seven days.
14. You can return to daily statistics by pressing the **Minus** button.
15. You can return to the temperature type selection by pressing the **Back** button.
16. Press the **Right arrow** button.

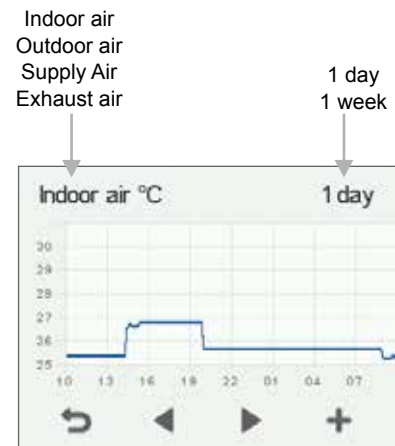

Indoor air temperature graph for the last 24 hours. The outdoor air and supply air values are presented on a similar display. You can view the graph for a week or for a single day.

Adroit® DV50 DV80 (Integral CO₂ Sensor)

TEMPERATURES AND SENSORS

1. A graph is opened, describing the supply air temperature over the last 24 hours.
2. If you want to view weekly statistics, press the **Plus** button.
3. A graph is opened, describing the supply air temperature over the last seven days.
4. You can return to daily statistics by pressing the **Minus** button.
5. You can return to the temperature type selection by pressing the **Back** button.
6. Press the **Right arrow** button.
7. A graph is opened, describing the waste air temperature over the last 24 hours.
8. If you want to view weekly statistics, press the **Plus** button.
9. A graph is opened, describing the waste air temperature over the last seven days.
10. You can return to daily statistics by pressing the **Minus** button.
11. You can return to the temperature type selection by pressing the **Back** button.
12. To exit the menu, press the **Back** button.



VIEWING HUMIDITY AND CARBON DIOXIDE VALUES

If you want to view individual humidity and carbon dioxide sensor data, proceed as follows:

- ☰ 1. Select **Settings > Temperatures and sensors**.
- 2. Press the **OK** button.
- 3. The temperature and sensors summary screen is opened.
- 4. Press the **Right arrow** button.
- 5. A screen displaying the maximum humidity value from the air humidity sensors is opened. The value refers to the relative humidity of the air.
- 6. Press the **Right arrow** button.
- 7. A screen displaying the maximum humidity value from the air humidity extract air sensor is opened again.
- 8. Press the **Right arrow** button.
- 9. A screen displaying the maximum carbon dioxide value from the air carbon dioxide extract air sensor is opened.
- 10. Press the **Right arrow** button.
- 11. A screen displaying the maximum carbon dioxide value from the air carbon dioxide extract air sensor is opened again.
- 12. To exit the menu, press the **Back** button.

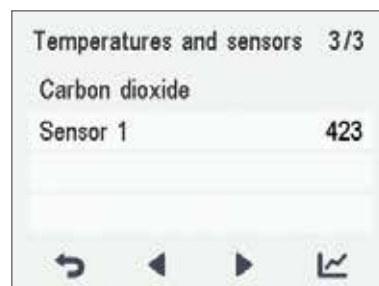
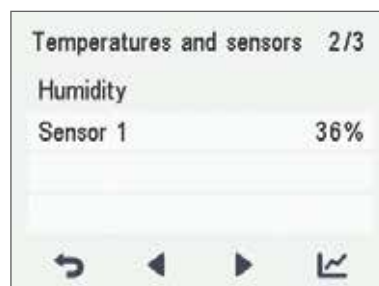

Adroit® DV50 DV80 (Integral CO₂ Sensor)

TEMPERATURES AND SENSORS

VIEWING HUMIDITY AND CARBON DIOXIDE STATISTICS

If you want to view statistics on the humidity and carbon dioxide values, proceed as follows:

1. Select **Settings > Temperatures and sensors**.
2. Press the **OK** button.
3. The temperature and supply and extract air sensors summary screen is opened.
4. Press the **Right arrow** button.
5. A screen displaying the values of the humidity extract air sensor 1-3 is opened.
6. Press the **Statistics** button.
7. A graph is opened, describing the values from the humidity sensor that gave the largest humidity value over the last 24 hours.
8. To view weekly statistics, press the **Plus** button.
9. A graph is opened, describing the values from the humidity sensor that gave the largest humidity value over the last seven days.
10. You can return to daily statistics by pressing the **Minus** button.
11. You can return to the sensor group selection by pressing the **Back** button.
12. Press the **Right arrow** button twice.
13. A screen displaying the values of the carbon dioxide extract air sensor 1-3 is opened.
14. Press the **Statistics** button.
15. A graph is opened, describing the values from the carbon dioxide sensor that gave the largest carbon dioxide value over the last 24 hours.
16. If you want to view weekly statistics, press the **Plus** button.
17. A graph is opened, describing the values from the carbon dioxide sensor that gave the largest carbon dioxide value over the last seven days.
18. A graph opens on the display showing the carbon dioxide level recorded over the last seven days by the extract air sensor with the highest values.
19. You can return to daily statistics by pressing the **Minus** button.
20. Return to the sensor group selection and exit by pressing the **Back** button twice.

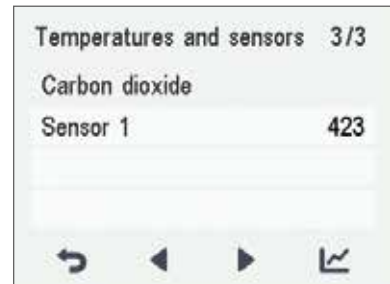
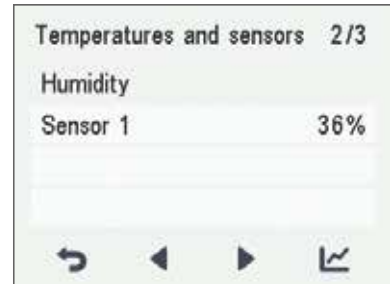

RELATIVE HUMIDITY OF AIR AND CARBON DIOXIDE LEVEL GRAPHS

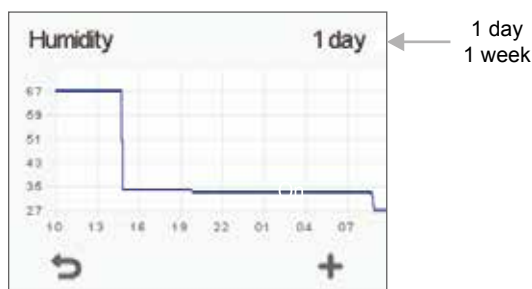

Relative humidity of air statistics for the past 24 hours. You can view the graph for a week or for a single day.

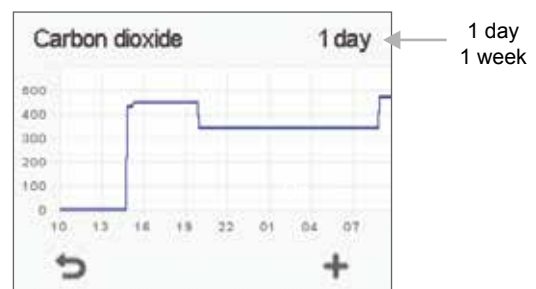

Carbon dioxide statistics for the past week. You can view the graph for a week or for a single day.

Adroit® DV50 DV80 (Integral CO₂ Sensor)

SETTINGS

FILTER SETTINGS

If you want to browse through the filter settings, proceed as follows:

- 1. Select **Settings > Filters**.
- 2. Press the **OK** button.
- 3. The Filters status summary screen is opened.
- 4. This screen contains the following information:
 - **Filters changed** — Indicates the date when the filter was last replaced.
 - **Next reminder** — Indicates the date when a reminder to replace the filter will next be shown.
 - **Reminder interval** — Indicates the filter replacement interval in months.

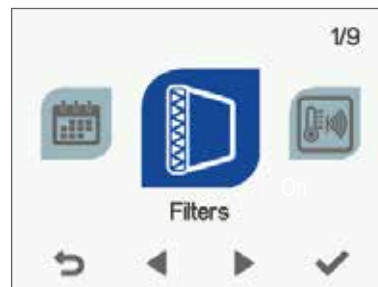

SETTING THE DATE THE FILTERS WERE LAST REPLACED

This section describes how to enter information in the controller on replacing the ventilation unit filter. Replacing the filter itself is described in the ventilation unit maintenance instructions.

If you want to set the date for replacing the ventilation unit filter, proceed as follows:

- 1. Select **Settings > Filters**.
- 2. Press the **OK** button.
- 3. The filter status summary screen is opened.
- 4. Press the **Edit** button.
- 5. The **Filter status** 1/2 screen is opened.
- 6. Press the **Plus** button. The **Filters changed** field value changes to **Today**.
- 7. Press the **OK** button.

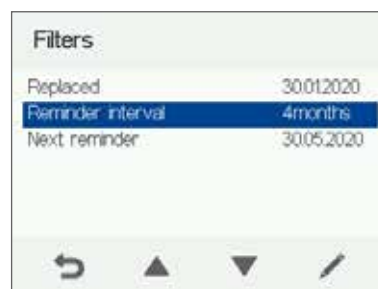
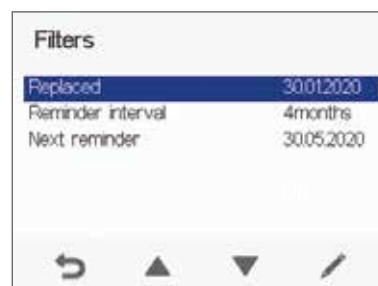

Adroit® DV50 DV80 (Integral CO₂ Sensor)

SETTINGS



NOTE

The system will automatically set the service reminder to remind you of the filter replacement. The reminder will be displayed when the set reminder interval has elapsed.

SETTING THE FILTER REPLACEMENT REMINDER INTERVAL

This section describes how to set the filter replacement reminder interval.

If you want to set the reminder interval for replacing the ventilation unit filter, proceed as follows:

1. Select **Settings > Filter**.
2. Press the **OK** button.
3. The filter status summary screen is opened.
4. Press the **Edit** button.
5. Press the **Right arrow** button.
6. The **Filter status 2/2** screen is opened.
7. Set the desired reminder interval in months in the **Reminder interval** field by using the **Plus** and **Minus** buttons. You can set the interval value from 1 to 12 months. The factory setting is 4 months.
8. Press the **OK** button.

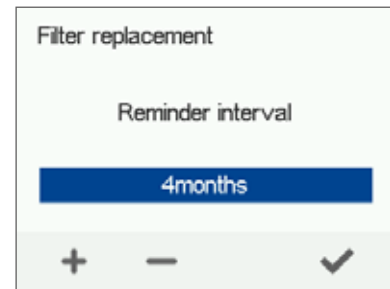

FILTER MAINTENANCE REMINDER

The maintenance reminder reminds you of the filter replacement with a pop-up window.

To acknowledge the maintenance reminder message, press the OK button.

Press the clock button to postpone the reminder for one week.



Adroit® DV50 DV80 (Integral CO₂ Sensor)

SETTINGS

DISPLAY SETTINGS

SETTING THE SLEEP TIME

The controller automatically switches to sleep mode when the pre-set sleep time has elapsed. To set the sleep time, proceed as follows:

1. Select **Settings > Display settings**.
2. Press the **OK** button.
3. The Display settings 1/2 appears.
4. Use the **Plus** and **Minus** buttons to set the sleep time.
5. Press the **OK** button.

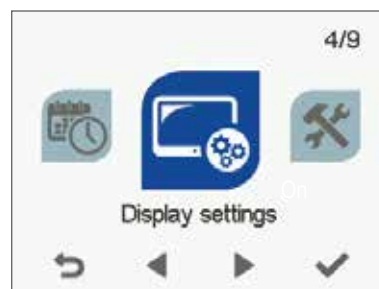

TIP

The Adroit Digital Controller automatically switches to sleep mode when the pre-set sleep time has elapsed. To reactivate the Adroit Digital Controller, press any button.

ADJUSTING THE DISPLAY BRIGHTNESS

To set the display brightness, proceed as follows:

1. Select **Settings > Display settings**.
2. Press the **OK** button.
3. The Display settings screen appears.
4. Press the **Right arrow** button.
5. **The Display settings 2/2** screen appears.
6. Use the **Plus** and **Minus** buttons to set the display brightness.
7. Press the **OK** button.



SELECTING THE USER INTERFACE LANGUAGE

You can select the user interface language as follows:

1. Select **Settings > Language**.
2. Press the **OK** button.
3. Select the language you want, for example, English.
4. Press the **OK** button.

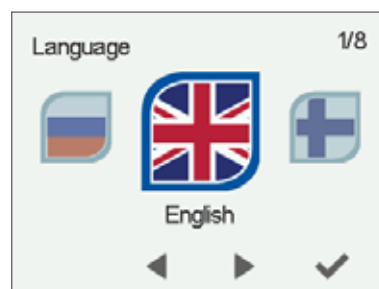

Adroit® DV50 DV80 (Integral CO₂ Sensor)

SETTINGS

TIME AND DATE

SETTING THE TIME AND DATE

The following sections explain how to set:

- Time
- 24- or 12-hour clock
- Automatic daylight-saving time
- Date



NOTE

The system time will stay active for a few hours if the power is cut to the unit.

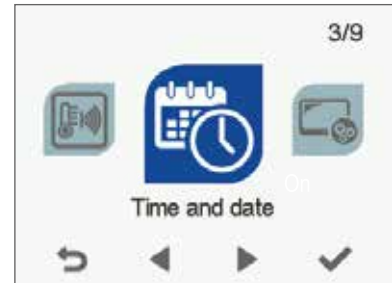

SETTING THE TIME

To set the time, proceed as follows:

1. Select **Settings > Time and date**.
2. Press the **OK** button.
3. The **Time and date** settings are opened.
4. Use the **Plus** and **Minus** buttons to set the hours.
5. Press the **Right arrow** button.
6. Use the **Plus** and **Minus** buttons to set the minutes.
7. Press the **OK** button.

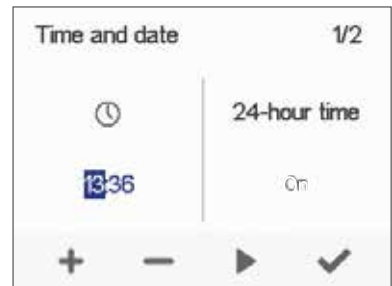

SELECTING THE 24- OR 12-HOUR CLOCK

By default, the system uses a 24 hour clock. If you want to use the 12 hour clock, proceed as follows:

1. Select **Settings > Time and date**.
2. Press the **OK** button.
3. The **Time and date** settings are opened.
4. Press the **Right arrow** until the display 2/4 opens.
5. Press the **Minus** button. The **24-Hour Time** setting value is changed to **Off**.
6. Press the **OK** button.

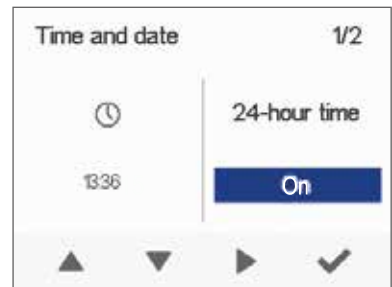

SETTING THE AUTOMATIC DAYLIGHT SAVING TIME

If you want the system to automatically switch over to daylight saving time, proceed as follows:

1. Select **Settings > Time and date**.
2. Press the **OK** button.
3. The **Time and date** settings open.
4. Press the **Right arrow** until the display 3/4 opens.
5. Press the **Plus** button. The **Daylight saving time** setting value is changed to **On**.
6. Press the **OK** button.

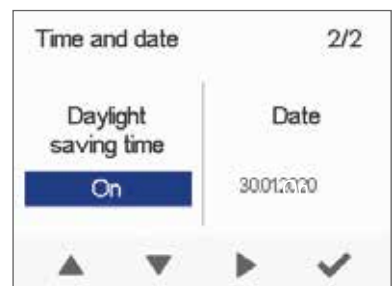

Adroit® DV50 DV80 (Integral CO₂ Sensor)

SETTINGS

TIME AND DATE

SETTING THE DATE

To set the date, proceed as follows:

1. Select **Settings > Time and date**.
2. Press the **OK** button.
3. The **Time** and **date** settings are opened.
4. Press the **Right arrow** until the display 4/4 appears.
5. Use the **Plus** and **Minus** buttons to set the date.
6. Press the **Right arrow** button.
7. Use the **Plus** and **Minus** buttons to set the month.
8. Press the **Right arrow** button.
9. Use the **Plus** and **Minus** buttons to set the year.
10. Press the **OK** button.

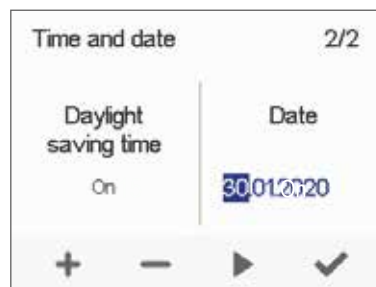

WEEK CLOCK

The Week clock allows you to program a weekly program for the ventilation unit. The program controls the unit by changing the ventilation profile. You can set one of the following conditions for each hour of the week:

- **At Home** — Use the **At home** profile.
- **Away** — Use the **Away** profile.
- **Boost** — Use the **Boost** profile.
- **Custom** — Use the **Custom** profile.
- **Standby** — The ventilation unit has been turned off.
- **Empty** — The previous mode is used.

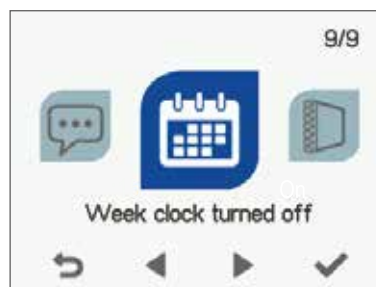

NOTE

If you change the profile manually when the Week clock is on, the selected profile will be active until the Week clock switches to the next profile in the program.

If the humidity or carbon dioxide sensors control the ventilation, they will adjust the fan speed, regardless of whether the profile has been manually selected or selected by the Week clock.

ENABLING THE WEEK CLOCK ON

To turn the Week clock on, proceed as follows:

1. Select **Settings > Week clock**.
2. Press the **OK** button.
3. The week view in the Week clock is displayed.
4. Press the **Settings** button.
5. The **Week clock menu** appears.
6. Select **Turn on**.
7. Press the **Select** button.
8. A confirmation screen is opened.

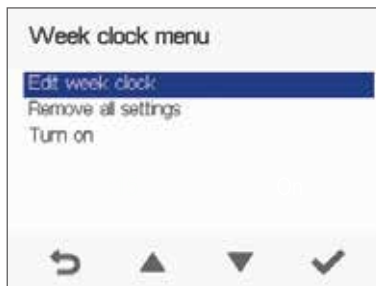

TIP

You can switch the Week clock **ON** or **OFF** by pressing the **OK** button in the **Week clock** screen for a few seconds.





Adroit® DV50 DV80 (Integral CO₂ Sensor)

SETTINGS

WEEK CLOCK

SETTING AND EDITING THE WEEKLY PROGRAM

If you want to set the weekly timer program or edit an existing program, proceed as follows:

1. Select **Settings > Week clock**.
2. Press the **OK** button.
3. The week view in the Week clock is displayed.
4. Use the **Right arrow** button to select the desired day.
5. Use the **Down arrow** button to select the desired time.
6. Use the **Select** button to browse and select the ventilation profile that will be turned on at the chosen time. Use the **Select** button to browse the profile icons. The icons are:
 -  • This icon selects the **At home** profile.
 -  • This icon selects the **Away** profile.
 -  • This icon selects the **Boost** profile.
 -  • This icon selects the **Custom** profile.
 -  • This icon selects the **Standby** profile.
7. Set the other profile changes for the Week clock as described above.
8. Press the **Settings** button.
9. The **Week clock menu** opens.
10. Select **Save and Quit**.
11. To exit without saving the weekly program or changes, select **Cancel and Quit**.
12. A confirmation display opens.
13. Press the **OK** button.

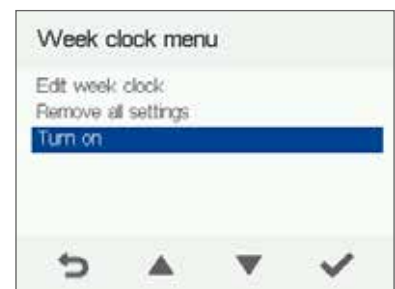
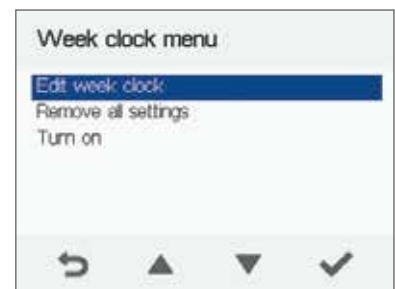

TURNING THE WEEK CLOCK OFF

If you want to disable the Week clock, proceed as follows:

1. Select **Settings > Week clock**.
2. Press the **OK** button.
3. Press the **Settings** button.
4. **The Week clock menu** opens.
5. Select **Turn Off**.
6. Press the **Select** button.
7. A confirmation screen is opened.
8. The Week clock is now disabled. If you have set a weekly program, it will be saved in the system.

Adroit® DV50 DV80 (Integral CO₂ Sensor)

SETTINGS

REMOVING THE WEEKLY PROGRAM

If you want to remove the weekly program settings from the system, proceed as follows:

1. Select **Settings > Week clock**.
2. Press the **OK** button.
3. Press the **Settings** button.
4. The **Week clock menu** opens.
5. Select **Remove all settings**.
6. The confirmation screen for removing the weekly program is opened.
7. Press the **OK** button.
8. A confirmation screen is opened.
9. The Week clock program has now been deleted from the system.

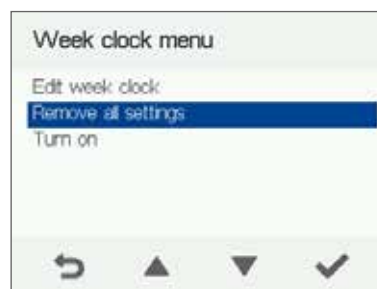

EXAMPLE OF SETTING A WEEKLY PROGRAM

In this example, the following weekly program has been set:

- Mon-Fri 08.00 - 17.00, **Away** from home.
- Mon-Fri 17.00 - 08.00, **At home**.
- Sat 08.00 - 18.00, **At home**.
- Sat 18.00 - 21.00, **Boost** that might be needed for cooking.
- Sat 21.00 - Mon 08.00, **At home**

To set the Week clock, proceed as follows:

1. Open the Week clock.
2. Select Monday and make the following settings:
 - At 8.00, select the **Away** profile.
 - At 17.00, select the **At home** profile.
3. Also make the corresponding settings for other weekdays.
4. Select Saturday and make the following settings:
 - At 18.00, select the **Boost** profile.
 - At 21.00, select the **At home** profile.
5. Ensure that the Week clock is enabled.
6. The weekly program is now set



The figures above depict a Week clock set in line with this example.

Adroit® DV50 DV80 (Integral CO₂ Sensor)

SETTINGS

PARTIAL BY-PASS

To turn the partial by-pass on:

- 1. Select **Expert** settings.
- 2. Find **HR cell bypass** settings.
- 3. Select **On** from the pop down list menu of the Partial bypass option.
- 4. The partial bypass has now been turned on and will run automatically based on temperature sensors inputs.
- 5. The partial bypass can also be used in Special modes option, which means that the partial bypass can be active during winter as well, only for special cases, e.g. used in a server room that generates heat.

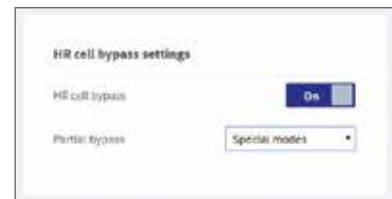
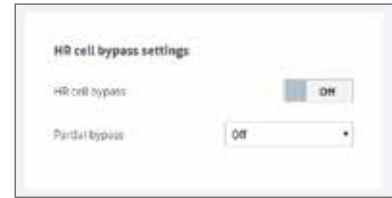

NOTE

The purpose of the partial bypass option is to provide a supply air temperature as accurate as possible. This automatic partial bypass will function based on the outdoor and extract air temperatures. For instance, during the spring and autumn a high amount of heat gain is coming from the sun, but the outdoor air can still have a fairly low temperature. So, if the supply air goes through the heat exchanger, the supply air temperature can be too high. Same for the case where the supply air is bypassed and no heat is being recovered, the supply air temperature can be too cold.

However, if the supply air temperature is set e.g. at 16° Celsius, the bypass damper will move into a suitable position where enough outdoor air is mixed with the supply air the outcome is providing a more accurate supply air temperature of 16° Celsius.

SWITCHING THE UNIT OFF

To turn the ventilation unit off:

- 1. Select **Settings> Turn unit off**.
- 2. Press the **OK** button.
- 3. The system asks for confirmation.
- 4. Press the **OK** button.
- 5. The ventilation unit has now been turned off



TIP

To re-start the ventilation unit, press any key. We advise against switching off the unit as the chosen ventilation system is continuous.



Adroit® DV50 DV80 (Integral CO₂ Sensor)

MAINTENANCE INSTRUCTIONS

BEFORE BEGINNING MAINTENANCE WORK

The safety switch (T) automatically turns off the power when the door of the ventilation unit is opened. Always disconnect the power before starting the ventilation unit maintenance.

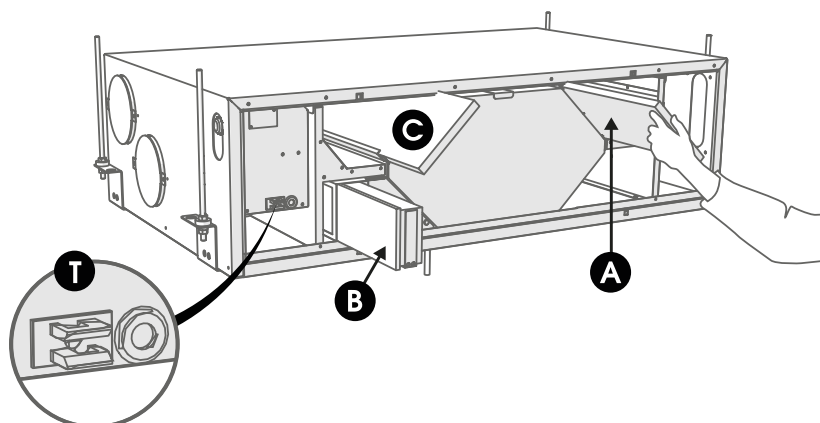

DV50 / 80 FILTERS AND HEAT RECOVERY CELL.

The units are available as right and left handed versions. In the right handed version (model R), outdoor air blows into the unit from the right side of the centre line as shown in the instructions. In the left handed version (model L), outdoor air blows into the unit from the left side. The location of the filters, summer/winter damper, and optional post-heater is also mirrored.

FILTERS

When the maintenance reminder becomes activated, check the cleanliness of the filters and replace them if required.

The Adroit ventilation unit has three air filters:

- Class G4 coarse filter (A) filters insects, heavy pollen and other relatively large foreign objects out of the outdoor air.
- Class F7 fine filter (B) filters microscopic pollen and dust particles out of the supply air.
- The coarse filter (C) filters the extract air and keeps the heat recovery cell clean.

To replace the filters:

1. Disconnect the ventilation unit from the mains electricity supply.
2. Open the door of the unit.
3. Lift the door off.
4. Remove the old filters (A, B, C) and discard them.
5. Install the new filters (A, B, C).
6. Close the door of the unit. Ensure that the safety switch of the door is engaged, allowing the unit to be turned on.
7. Connect the ventilation unit back into the mains.
8. The filters have now been successfully replaced.



Using original Airflow filters ensures that the ventilation unit remains in top condition, giving the best results. The filter replacement interval depends on the ambient dust concentration. It is recommended that the filters are replaced every spring and autumn or at the very least once a year.

Adroit® DV50 DV80 (Integral CO₂ Sensor)

MAINTENANCE INSTRUCTIONS

HEAT RECOVERY CELL

Check that the heat recovery cell (D) is clean every two years or whenever the filters are being replaced.



WARNING

Handle the heat recovery cell carefully! For example, do not lift the heat recovery cell by the layers. The heat recovery cell layers are very thin and can be easily damaged.

To check the heat recovery cell:

1. Disconnect the ventilation unit from the mains electricity supply.
2. Turn the latch to open the door of the ventilation unit.
3. Lift the door off.
4. Pull the ISO Coarse > 75% (G4) filters (A, C) and filter supports out of the unit.
5. Remove the sealing strip (E) above the heat recovery cell.
6. Remove the side sealing strip (F).
7. Remove the ISO ePM1 50% (F7) filter (B).
8. Place hands behind the heat recovery cell and pull it out slowly.
9. If the heat recovery cell is dirty, clean it by immersing it in warm water, to which a small amount of a mild detergent has been added.
10. Rinse the heat recovery cell clean with a water spray. Do not use a high-pressure cleaner.
11. When all the water has drained from between the layers, reassemble the ventilation unit in the reverse order.
12. Close the door and connect the unit back into the mains.
13. The heat recovery cell has now been checked and cleaned.

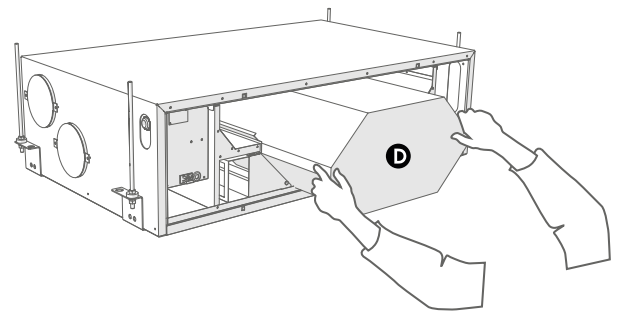
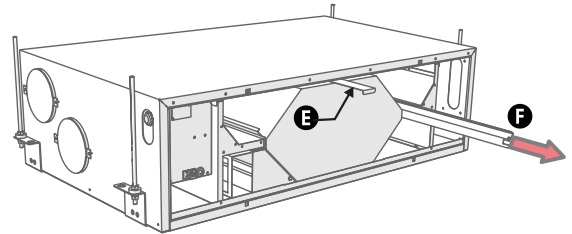

NOTE

If the unit has an enthalpy cell, it must not be washed. Only aluminium or plastic cells can be washed.

Adroit® DV50 DV80 (Integral CO₂ Sensor)

MAINTENANCE INSTRUCTIONS

FANS

Check the cleanliness of the fans when servicing the filters and the heat recovery cell. Clean the fans as required. You can clean the fan blades with compressed air or by brushing them gently. Do not remove or move the fan blade balancing weights.

! WARNING

The fans are extremely sensitive to external shocks and to minimize risk of damage to them. It is recommended that the fans be cleaned in place, i.e. without attempting to remove them.

CLEANING THE SUPPLY AIR FAN

NOTE

Remove the fan beds and the bypass duct carefully in accordance with the below instructions to prevent damage. The small size of the unit restricts the space available for servicing.

REMOVING AND CLEANING THE SUPPLY AIR FAN

This section describes how to remove the supply air fan of the right handed unit. The steps are mirrored for the left handed unit.

To remove and clean the supply air fan:

1. Disconnect the ventilation unit from the mains electricity supply.
2. Turn the latch to open the door of the ventilation unit.
3. Lift the door off.
4. Remove the extract air filter (C), the cell top bracket (E) and the heat recovery cell (D), as described in sections "Filters" and "Heat recovery cell".
5. Remove the mounting screws of the fan bed (2).
6. Pull the bypass duct/filter stand package out of the unit and turn to the right.
7. Remove the cable connector (black) of the fan and move the supply air fan slightly to the right.
8. Remove the post heating radiator connector. The post heating radiator connector can be removed once the supply air fan has been moved slightly to the right.
9. Tilt the supply air fan to the right and push the connectors out of the way. Turn the fan 90° and tilt it forward to pull it out of the unit.
10. The fan has now been removed for cleaning.
11. To reassemble the ventilation unit, follow the above steps in reverse order.
12. Close the door and connect the unit back into the mains.
13. The fan has now been checked and cleaned.

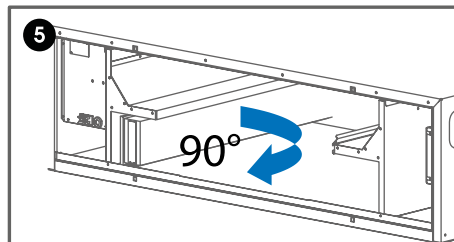
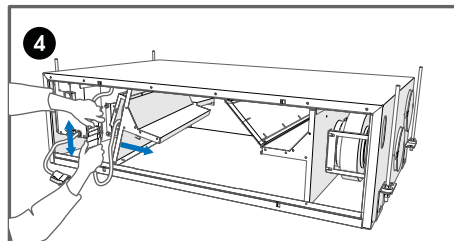
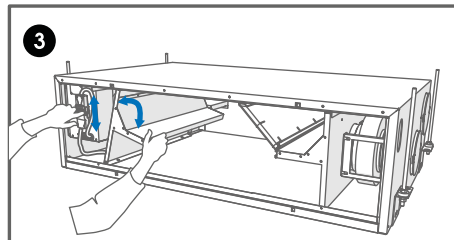
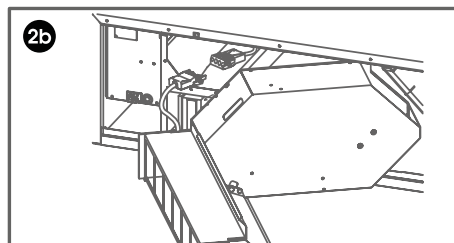
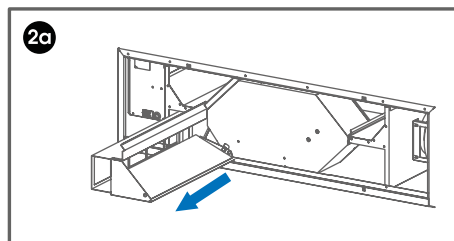
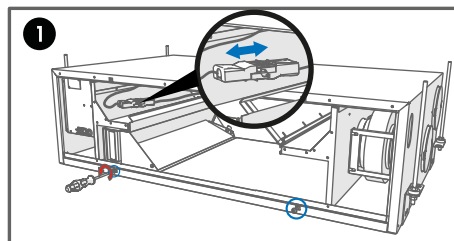

NOTE

Install the fan beds in a reverse order.

Adroit® DV50 DV80 (Integral CO₂ Sensor)

MAINTENANCE INSTRUCTIONS

REMOVING AND CLEANING THE EXTRACT AIR FAN

This section describes how to remove the extract air fan of the right handed unit. The steps are mirrored for the left handed unit.

To remove and clean the extract air fan:

1. Disconnect the ventilation unit from the mains electricity supply.
2. Turn the latch to open the door of the ventilation unit.
3. Lift the door off.
4. Remove the extract air filter (C), the cell top bracket (E) and the heat recovery cell (D), as described in sections "Filters" and "Heat recovery cell".
5. Remove the fan bed mounting screw (see removing the supply air fan, Figure 1).
6. Remove the connector package from the wall.
7. Separate the connectors from each other.
8. Tilt the fan to the left and turn 90°.
9. Tilt the fan forward to pull it out of the unit.
10. The fan has now been removed for cleaning.
11. To reassemble the ventilation unit, follow the above steps in reverse order.
12. Close the door and connect the unit back into the mains.
13. The fan has now been checked and cleaned.

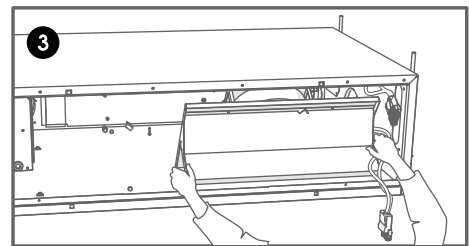
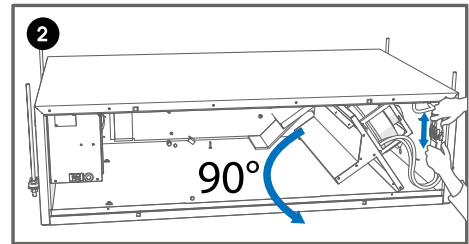
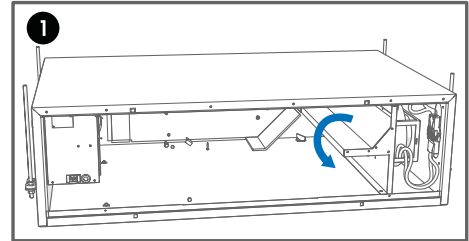

NOTE

Install the fan beds in a reverse order.

CONDENSING WATER

In the heating season, the extract air humidity condenses into water. In new buildings, condensation runoff can form rapidly. Condensed water must be able to freely leave the unit.

At some time before the heating season begins (e.g. during autumn maintenance), check that the condensing water outlet (L) in the bottom pool is not clogged. To check this, pour some water into the pool. Clean as required.

The unit is delivered with two condensing water outlets: one that has an air lock (see the Figure) and a more compact outlet that has not. When the outlet with no air lock is used, an air lock must be installed somewhere else between the extraction pipes (the parts needed are included in the accessory bag). The air lock ensures the removal of condensing water and muffles any noise.

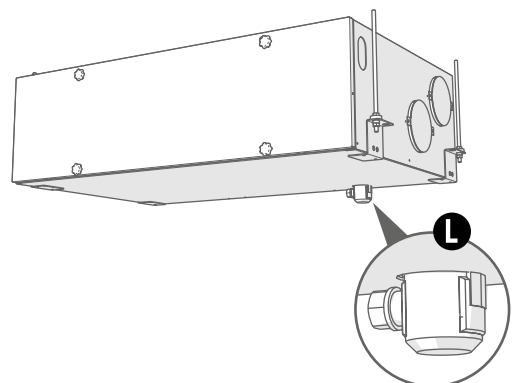

WARNING

Water must be kept out of the electrical system at all times.

Adroit® DV50 DV80 (Integral CO₂ Sensor)

MAINTENANCE INSTRUCTIONS

TROUBLESHOOTING

The table below contains troubleshooting and fault repair instructions.



NOTE

Error messages are displayed on the controller and in the ADROIT Home and ADROIT Cloud services.

FAULT	CAUSE	MEASURES
Message on the user interface: Extract fan stopped	The extract air fan has stopped.	Make sure that the fan is not running. The fan cabling and operation must be checked and if necessary, the fan must be replaced. Contact the service centre.
Message on the user interface: Supply fan stopped	The supply air fan has stopped.	Make sure that the fan is not running. The fan cabling and operation must be checked and if necessary, the fan must be replaced. Contact the service centre.
Message on the user interface: Heat recovery cell has frozen	The heat recovery cell has become excessively cold.	Conduct a manual defrost through the controller (Service menu > Cell defrost). Try to discover why the heat recovery cell is frozen.
Message on the user interface: Temperature sensor 1/2/3/4/5	The temperature sensor indicated on the user interface is damaged.	The sensor installation must be checked and if required, the sensor must be replaced. Contact the service centre.
Message on the user interface: External sensor	The external temperature sensor is damaged.	The sensor installation must be checked and if required, the sensor must be replaced. Contact the service centre.
Message on the user interface: Post-heater	The post-heater does not heat.	The heater installation must be checked and if required, the heater must be replaced. Contact the service centre.
Message on the user interface: Bus fault	Problems with the data transfer bus.	Make sure that the Modbus bus is connected correctly and that the devices connected to it are properly functioning.
The ventilation unit is not working; the controller is not working.	Power input to the unit is lost.	Check: • Fuse in the fusebox • Fuse in the unit
The ventilation unit is working, but the controller is not working.	Either the controller 24 VDC power is lost, or the controller is damaged.	Check the cables from the unit to the controller. Contact the service centre if necessary.

Adroit® DV50 DV80 (Integral CO₂ Sensor)

MAINTENANCE INSTRUCTIONS

DV50 Adroit

Product descriptions DV50 (R) Adroit (Integral CO ₂ Sensor) DV50 (L) Adroit (Integral CO ₂ Sensor)	Product numbers: 90001273 90001274			
Air volumes Extract air Supply air	49 l/s, 100 Pa 57 l/s, 100 Pa	Fans	0.043 kW 0.32A EC 0.043 kW 0.32A EC	
Electrical connection	230V, 50Hz ~4.5A	Efficiencies	Annual efficiency Supply air efficiency Specific Fan Power (SFP)	79% A+ 86 % 1.3W/(l/s)
Enclosure protection class	IP34	Filters	Supply air Extract air	ISO Coarse > 75 % + ISO ePM, (G4, F7) ISO Coarse > 75% (G4) - ISO 16890 compliant
Optional post-heater	900W, 3.9 A	Heat recovery bypass		Automatic
Heat recovery	Cross-counter flow cell, h>80 %	Weight		47 kg
		Dimensions	(w x h x d)	900 x 236 x 547 mm

DV80 Adroit

Product descriptions DV80 (R) Adroit (Integral CO ₂ Sensor) DV80 (L) Adroit (Integral CO ₂ Sensor)	Product numbers: 90001275 90001276			
Air volumes Extract air Supply air	76 l/s, 100 Pa 93 l/s, 100 Pa	Fans	0.081 kW 0.65A EC 0.081 kW 0.65A EC	
Electrical connection	230 V, 50 Hz ~8.8 A	Efficiencies	Annual efficiency Supply air efficiency Specific Fan Power (SFP)	79% A+ 86% 1.2W/(l/s)
Enclosure protection class	IP34	Filters	Supply air Extract air	ISO Coarse > 75 % + ISO ePM, (G4, F7) ISO Coarse > 75% (G4) - ISO 16890 compliant
Optional post-heater	900W, 3.9 A	Heat recovery bypass		Motorized summer/ winter damper
Heat recovery	Cross-counter flow cell, h>80 %	Weight		61 kg
		Dimensions	(w x h x d)	1026 x 293 x 626mm

Adroit® DV50 DV80 (Integral CO₂ Sensor)

DV50 ADROIT TECHNICAL SPECIFICATIONS

MEASUREMENT POINTS

Measurement points after the connection outlet. The fan curves indicate the total pressure accounted for by duct losses.

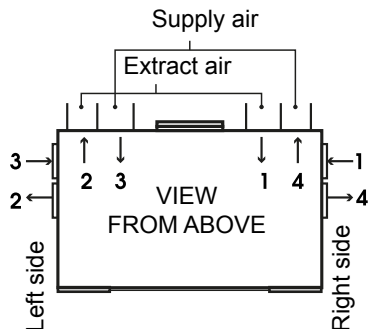

FAN INPUT POWER

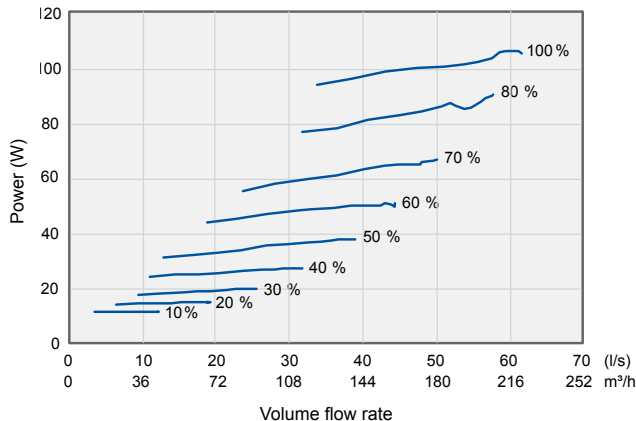

AIR VOLUMES DV ADROIT, SUPPLY AIR ISO COARSE > 75 % + ISO EPM, (G4, F7), EXTRACT AIR ISO COARSE > 75% (G4)

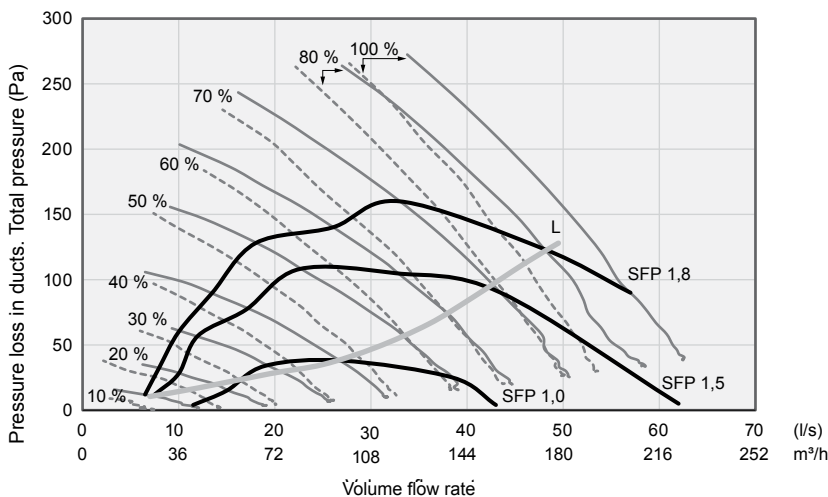

PK and TK are examples of pressure loss in the supply and extract air ducts.

SFP rate (Specific Fan Power) recommended value <1.8 (kW m³/s)

$$SFP = \frac{\text{Input power (total W)}}{\text{Air flow (max) (l/s)}}$$

SOUND VALUES

Adjustment position (%)	Sound power level in the supply air duct (one duct) by octave band L _w , dB										Sound power level in the extract air duct (one duct) by octave band L _w , dB							
	Adjustable position										Adjustable position							
	10	20	30	40	50	60	70	80	100	10	20	30	40	50	60	70	80	100
Air flow	6	10	17	21	26	32	35	40	44	7	14	22	24	30	35	40	45	48
Medium frequency of the octave band Hz	63	59	66	70	72	74	79	78	81	55	59	61	64	67	76	72	74	73
	125	57	62	64	66	69	71	73	76	57	60	62	66	68	70	72	74	77
	250	47	55	62	66	68	69	71	73	39	47	55	60	61	62	63	65	67
	500	36	44	50	55	59	63	66	68	26	33	38	42	47	52	55	57	57
	1000	29	39	45	50	54	59	61	63	21	29	34	38	42	45	48	50	52
	2000	21	29	39	45	50	53	56	58	13	15	22	27	32	35	37	39	41
	4000	18	19	24	32	40	46	50	53	17	17	18	18	21	25	28	32	34
8000	21	21	22	23	26	31	36	40	21	22	21	21	22	22	22	22	23	
L _w , dB	62	67	71	74	76	80	80	81	59	62	65	69	71	77	75	77	79	
L _{WA} , dB(A)	44	51	56	60	63	66	68	72	41	45	50	54	56	58	60	62	64	
Sound pressure level coming through the envelope of the unit in the room in which it is installed (10m ² sound absorption)																		
Adjustable position																		
Adjustment position (%)	10	20	30	40	50	60	70	80	100									
Air flow	6/7	12/14	19/22	22/25	27/30	31/34	35/40	41/45	44/48									
L _{pA} , dB (A)	24	29	35	38	40	45	47	49	50									

Adroit® DV50 DV80 (Integral CO₂ Sensor)

DV80 ADROIT TECHNICAL SPECIFICATIONS

MEASUREMENT POINTS

Measurement points after the connection outlet. The fan curves indicate the total pressure accounted for by duct losses.

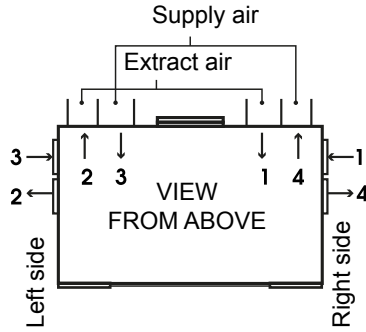

FAN INPUT POWER

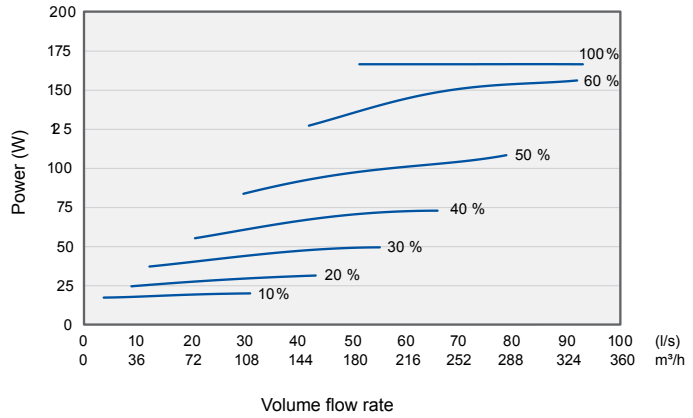

AIR VOLUMES DV ADROIT, SUPPLY AIR ISO COARSE > 75% + ISO EPM, (G4, F7), EXTRACT AIR ISO COARSE > 75% (G4)

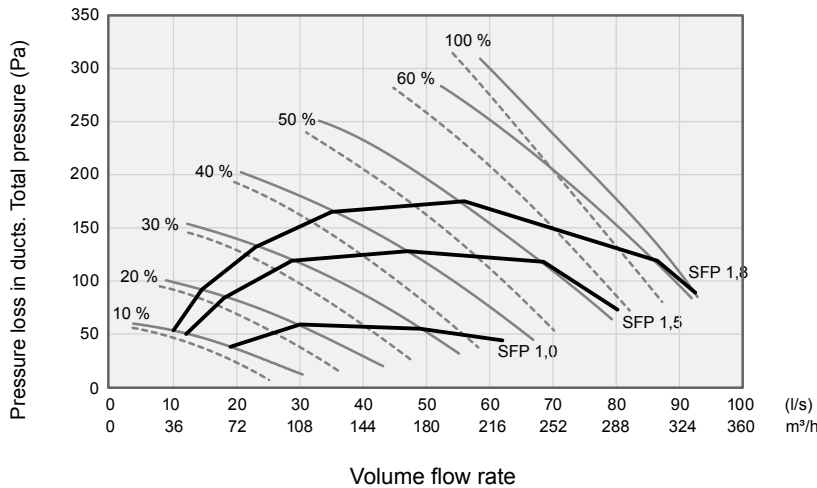

PK and TK are examples of pressure loss in the supply and extract air ducts.

SFP rate (Specific Fan Power) recommended value < 1.8 (kW m³/s)

$$SFP = \frac{\text{Input power (total W)}}{\text{Air flow (max) (l/s)}}$$

SOUND VALUES

Adjustment position (%)	Sound power level in the supply air duct (one duct) by octave band Lw, dB										Sound power level in the extract air duct (one duct) by octave band Lw, dB									
	Adjustable position										Adjustable position									
	10	20	30	40	50	60	70	80	90	100	10	20	30	40	50	60	70	80	90	100
Air flow l/s	15	20	32	37	47	57	62			65	17	22	36	42	51	60	66			67
Medium frequency of the octave band Hz	63	60	67	68	72	73	79	79		78	54	58	59	63	66	78	70			73
	125	56	65	64	66	68	70	72		73	48	56	54	56	58	62	63			64
	250	51	58	67	70	74	78	76		76	43	50	61	59	61	63	65			64
	500	41	49	55	59	63	66	70		70	30	37	43	46	49	53	60			60
	1000	39	47	52	55	58	62	65		66	27	35	39	43	46	50	52			53
	2000	30	41	48	52	56	59	62		62	15	23	29	33	37	40	42			43
4000	19	28	36	42	46	51	54		55	17	17	18	21	25	29	31			32	
8000	21	22	28	35	42	48	52		53	21	21	21	21	22	23	25			26	
LW, dB	61	70	72	75	77	82	82		81	55	61	64	65	68	78	72			74	
LWA, dB(A)	46	55	61	64	68	72	72		75	38	45	53	52	54	58	61			61	
Sound pressure level coming through the envelope of the unit in the room in which it is installed (10m² sound absorption)																				
Adjustable position																				
Adjustment position (%)	10	20	30	40	50	60	70	80	90	100	10	20	30	40	50	60	70	80	90	100
Air flow l/s	15/17	33/39	32/36	38/42	47/51	57/60	62/67			65/67	15/17	33/39	32/36	38/42	47/51	57/60	62/67			65/67
LpA, dB (A)	27	33	40	43	46	50	52			52	27	33	40	43	46	50	52			52

Adroit® DV50 DV80 (Integral CO₂ Sensor)

INTERNAL ELECTRICAL CONNECTION

CABLE COLOURS

BK	Black
BU	Blue
BN	Brown
WT	White
GY	Grey
YE	Yellow
YEGN	Yellow-green

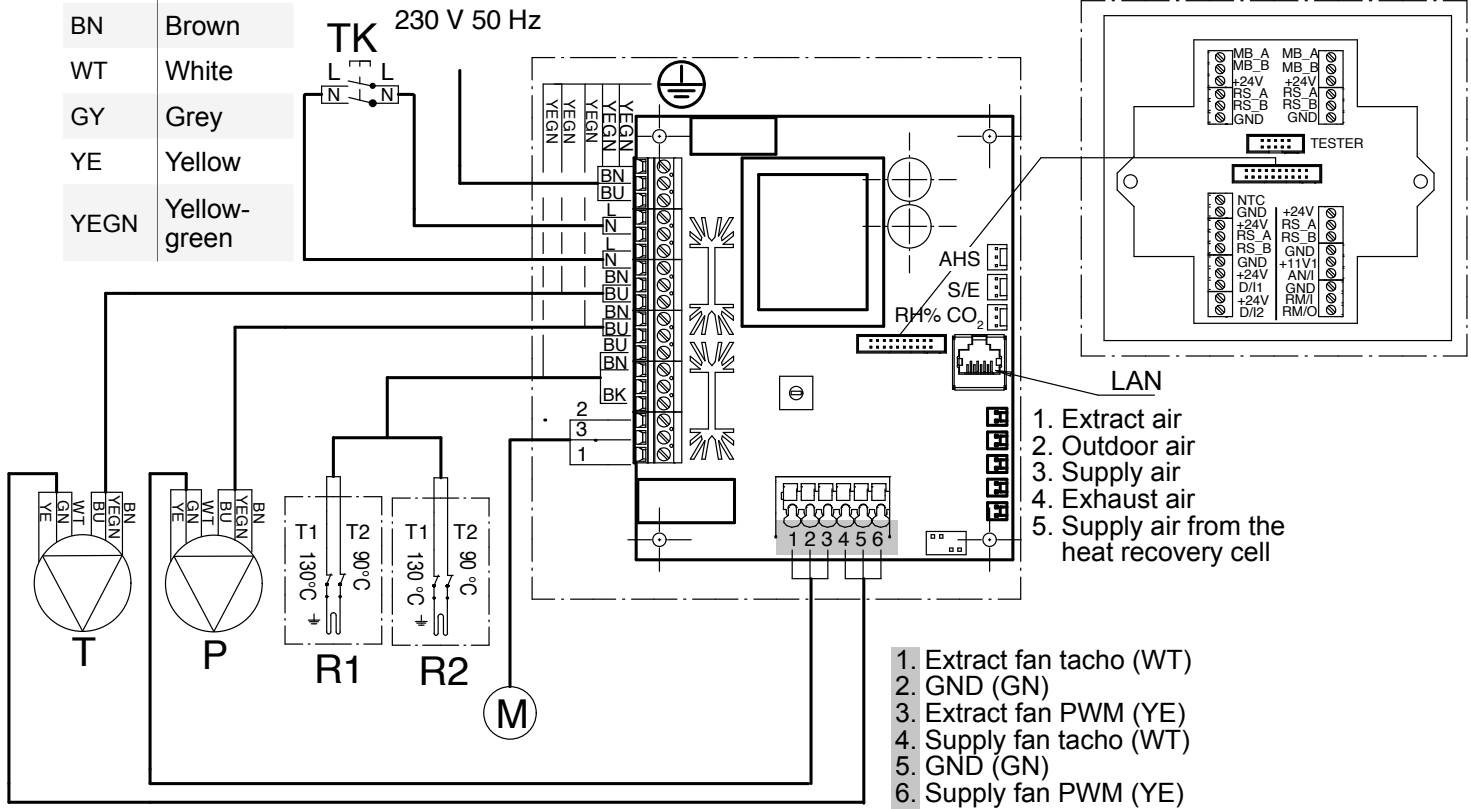

MB_A	External Modbus A signal
MB_B	External Modbus B signal
+24V	+24 V direct current voltage (DC)
GND	Digital and analog ground potential
RS_A	Local hardware Modbus A signal
RS_B	Local hardware Modbus B signal
NTC	External temperature sensor connector
D/I1	Digital input 1
D/I2	Digital input 2
11V1	11.1 V operating voltage
AN/I	Analog input 0-10 VDC
RM/I	24 V relay input
RM/O	24 V relay output

T	Supply air fan
P	Extract air fan
M	Damper actuator CM230-R
TK	Safety switch
AHS	Post-heating control
S/E	Fan balance adjustment
RH% CO ₂	Internal humidity and dioxide carbon sensor
R1	Optional post-heater with 90°C and 130°C overheating protection
R2	Optional additional heater radiator with 90°C and 130°C overheating protection

ST 007300 JS

Adroit® DV50 DV80 (Integral CO₂ Sensor)

EXTERNAL ELECTRICAL CONNECTION

POWER SUPPLY

Maximum	≤6W
Adroit digital Controller	1W
Adroit RH% transmitter	0.3W
Adroit CO ₂ transmitter	1.2W
Voltage	24 VDC

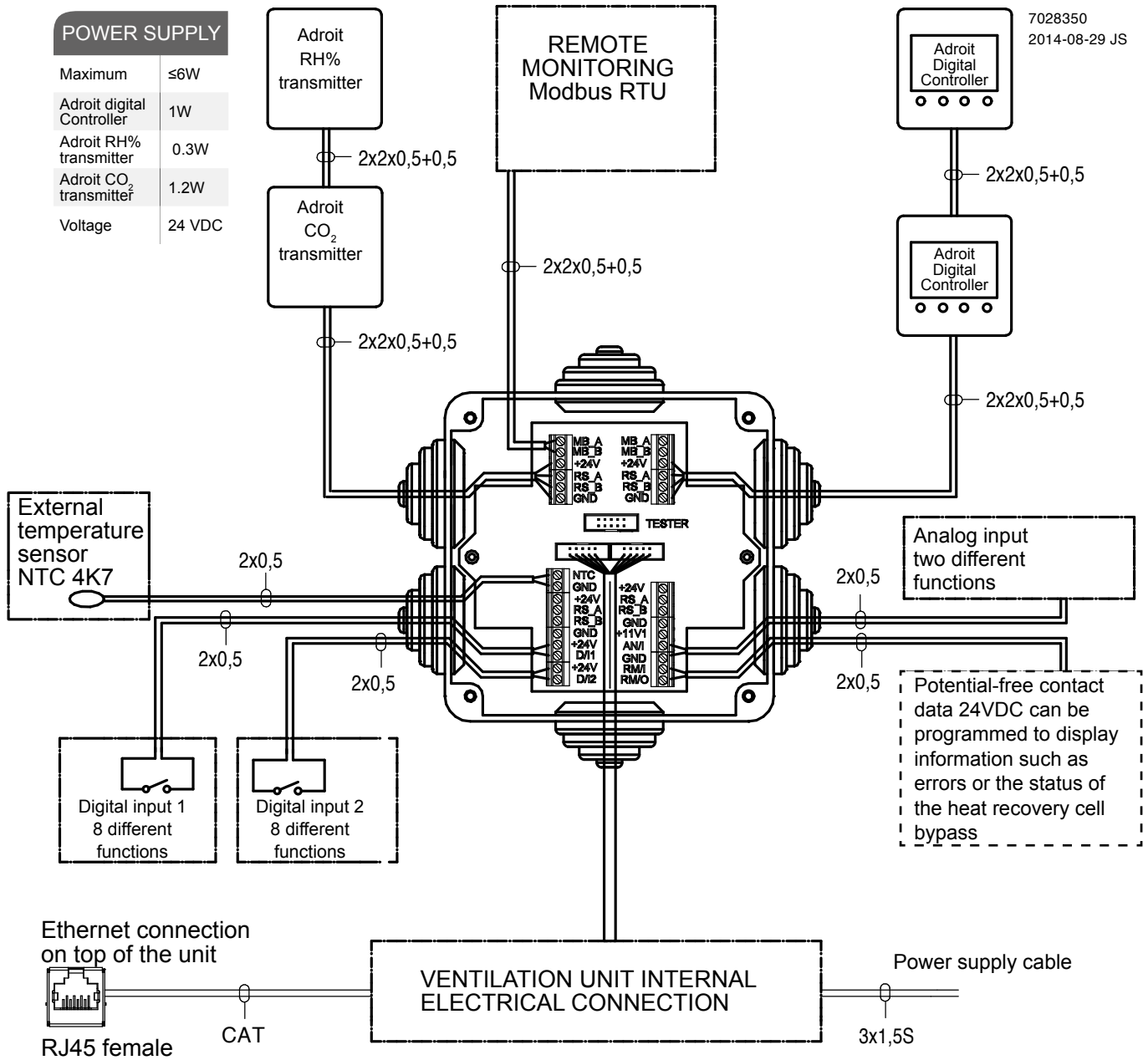

7028350
2014-08-29 JS

MB_A	External Modbus A signal	D/I1	Digital input 1
MB_B	External Modbus B signal	D/I2	Digital input 2
+24V	+24V direct current voltage (DC)	11V1	11.1 V operating voltage
GND	Digital and analog ground potential	AN/I	Analog input 0-10 VDC
RS_A	Local hardware Modbus A signal	RM/I	24 V relay input
RS_B	Local hardware Modbus B signal	RM/O	24 V relay output
NTC	External temperature sensor connector		

Adroit® DV50 DV80 (Integral CO₂ Sensor)

INSTALLATION

INSTALLATION SITE

DV 50 / 80 must be installed in a location where the temperature remains above +10 °C. When the unit is installed without a protective enclosure, the location must be chosen so that its noise does not cause any disturbance. Such locations include storage premises, technical spaces, and false ceilings.



NOTE

The whole length of the outdoor air duct to the unit and exhaust air duct from the unit must be insulated using closed cell insulation.

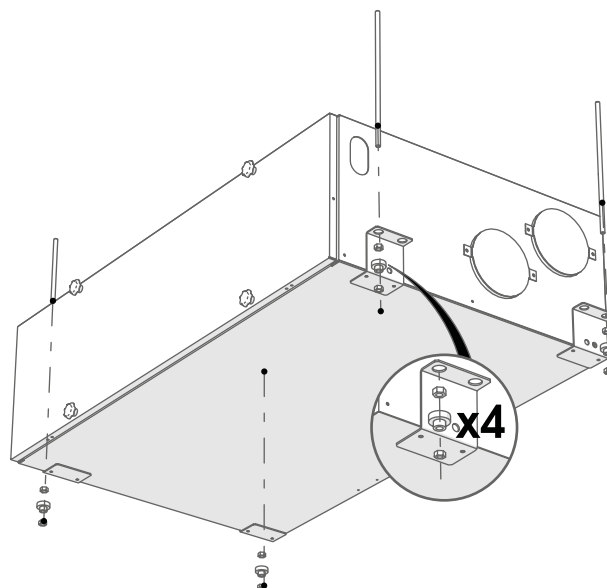

MOUNTING

The ventilation unit is normally installed on the ceiling using the mounting hooks (4) delivered with the unit. The weight of the unit (45 kg) must be taken into account when mounting the unit.



WARNING

The unit must be installed straight so that the condensing water that collects in the bottom pool drains through the condensing water outlet.

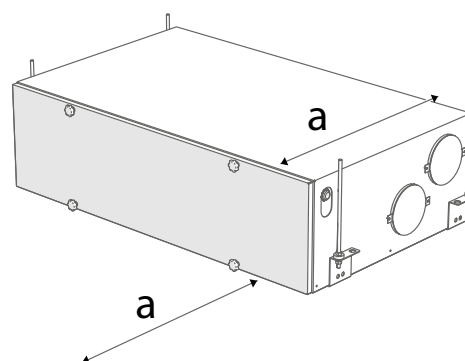

NOTE

Reserve a space equal to the depth of the unit in front of the unit for servicing purposes.

MEASURING TUBES

The accessories delivered with the unit include four ADROIT measuring tubes. These can be inserted in the ducts to allow for easier ventilation adjustment.

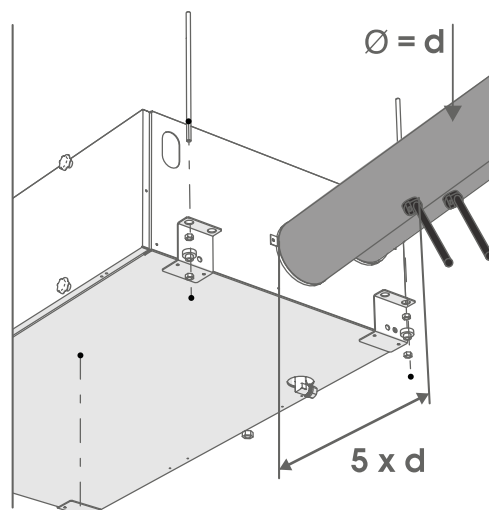
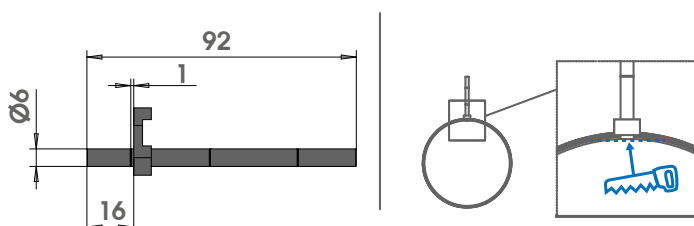

Adroit® DV50 DV80 (Integral CO₂ Sensor)

INSTALLATION

DIMENSIONS AND DUCT OUTLETS

UNIT DIMENSIONS		
Dimension	DV50 Adroit (Integral CO ₂ Sensor)	DV80 Adroit (Integral CO ₂ Sensor)
A	900	1026
B	547	626
C	236	293
D	100 (female)	125 (female)
E	87	110
F	197	254
G	86	110
H	161	200
I	161	200
J	86	96
K	96	96
L	206	231
M	498	624

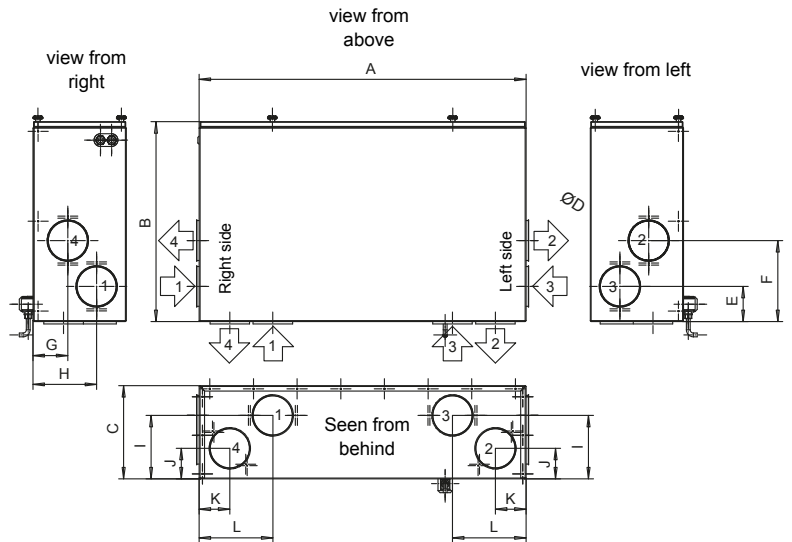

NOTE

Fold the NTC sensor holder if the supply air duct at the rear of the unit is used.
Ensure that the sensor cable is not in contact with the heater.

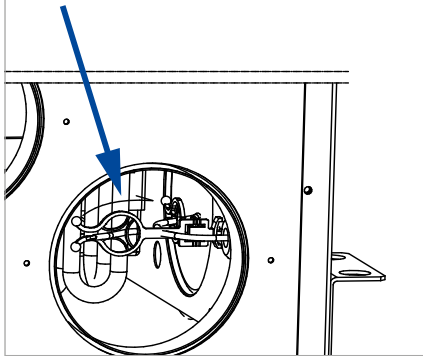

Model R:

1. Outdoor air to the unit
2. Supply air from the unit to the building
3. Extract air from the building to the unit
4. Exhaust air flowing outdoors from the unit
5. Condensate drain

w

1. Extract air from the building to the unit
2. Exhaust air flowing outdoors from the unit
3. Outdoor air to the unit
4. Supply air from the unit to the building
5. Condensate drain

UNIT DIMENSIONS		
Dimension	DV50 Adroit	DV80 Adroit
A	431	519
B	91	91
C	16	16
D	548	626
E	530	600
F	236	293
G	935	1060
H	900	1026

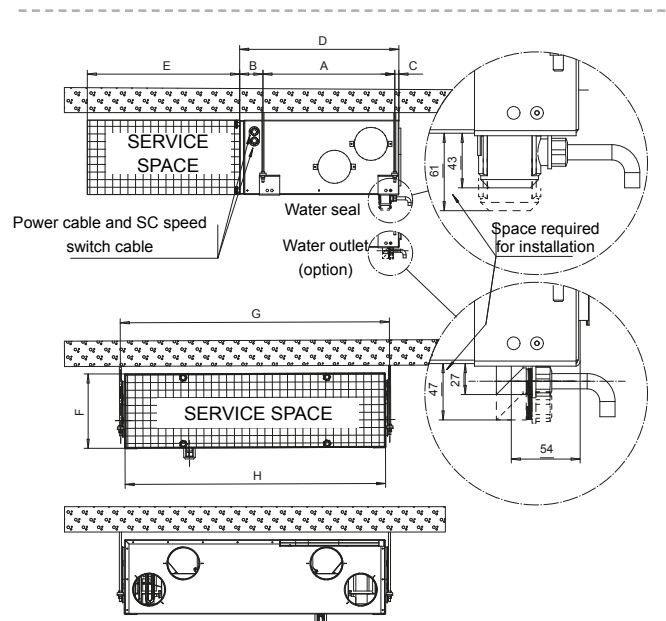

Adroit® DV50 DV80 (Integral CO₂ Sensor)

INSTALLATION

CONDENSING WATER

The delivery includes a water seal and a water outlet for connecting the pipe that leads the water condensed from the extract air to the floor drain (not directly into the sewer). The pipe must not rise after the water seal. See the accessory bag for further instructions on the installation of the water seal and the water outlet.

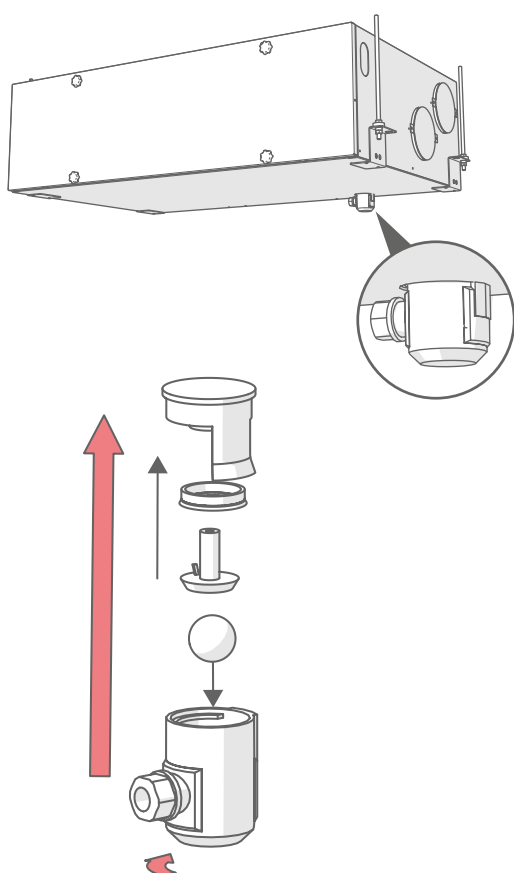

CONDENSING WATER OUTLET



WARNING

Water must be kept out of the electrical system at all times.

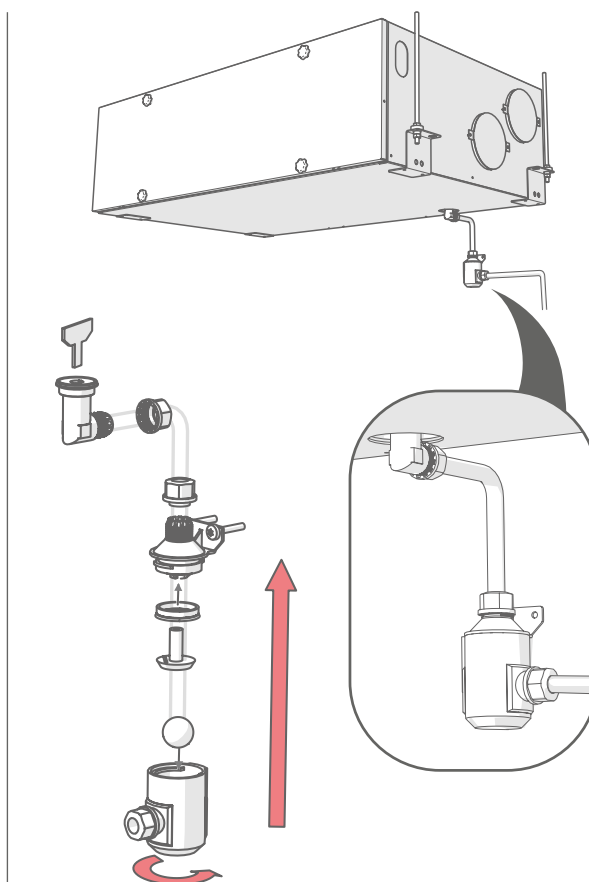

ALTERNATIVE WATER SEAL, WHICH CAN BE INSTALLED IN LOW SPACES



NOTE

If you use the alternative condensing water outlet, move the gasket ring and the locking part to the tube joint part that will be mounted on the wall.

Adroit® DV50 DV80 (Integral CO₂ Sensor)

EXPLODED VIEW AND PARTS LIST

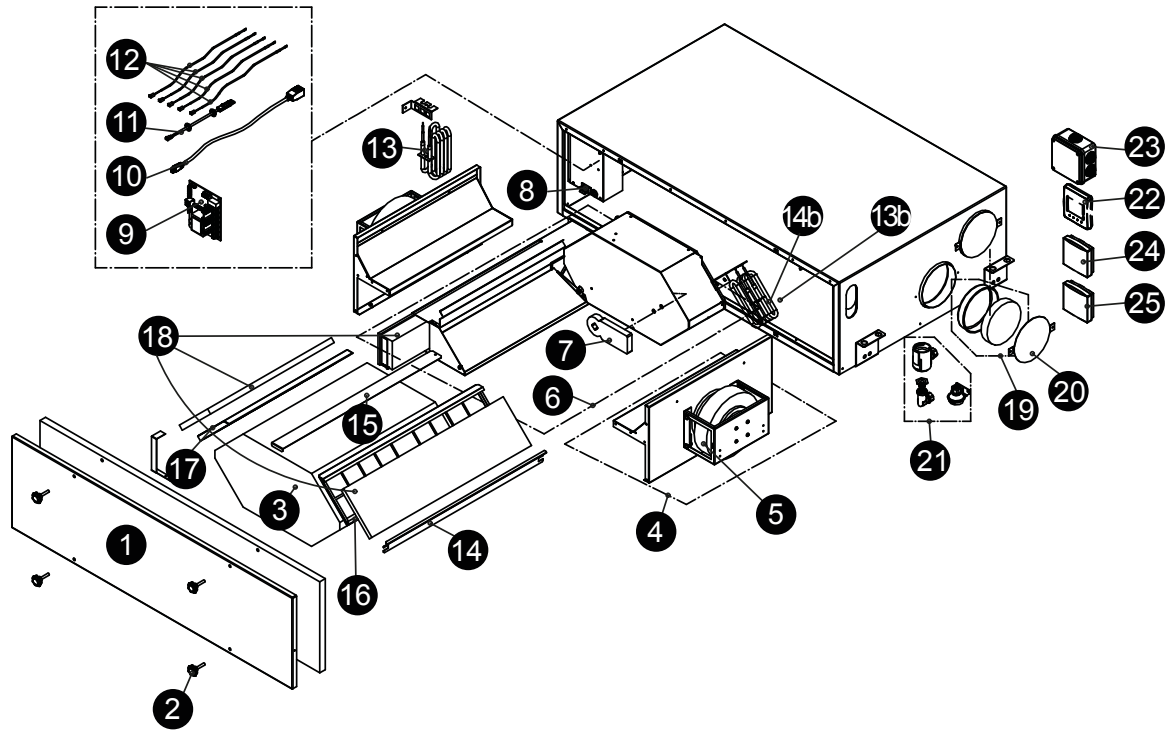

NO.	PART	CODE
1	Door assembly for DV50 Adroit (door plate, insulation, door switch button)	60000201
1	Door assembly for DV80 Adroit (door plate, insulation, door switch button)	60000202
2	Wing nut	60000203
3	HR cell for DV50 Adroit	60000211
3	HR cell for DV80 Adroit	60000213
4	DV50 Adroit fan assembly	60000215
4	DV80 Adroit fan assembly	60000217
5	DV50 Adroit fan motor	60000214
5	DV80 Adroit fan motor	60000216
6	Bypass duct assembly for DV50 (R) Adroit	60000251
6	Bypass duct assembly for DV50 (L) Adroit	60000252
6	Bypass duct assembly for DV80 (R) Adroit	60000253
6	Bypass duct assembly for DV80 (L) Adroit	60000273
7	DV50/DV80 Adroit bypass damper motor	60000206
8	Safety switch	60000581
9	Adroit motherboard	60000195
10	RJ45 extension cable	60000591
11	Built-in humidity sensor	60000220
12	NTC sensor (1pc.)	60000134
13	Post-heater 900W (optional) DV50&80 R model	60000131
13	Post-heater 900W (optional) DV50&80 L model	60000132
13b	Additional heater 900W (optional) DV80 R model	60000131
13b	Additional heater 900W (optional) DV80 L model	60000132

NO.	PART	CODE
14	Side sealing strip of the heat recovery for DV50 Adroit	60000276
14	Side sealing strip of the heat recovery for DV80 Adroit	60000277
15	Upper sealing strip of the heat recovery for DV50 Adroit	60000278
15	Upper sealing strip of the heat recovery for DV80 Adroit	60000322
16	Outdoor air ISO Coarse > 75% (G4) filter stand for DV50 Adroit	60000323
16	Outdoor air ISO Coarse > 75% (G4) filter stand for DV80 Adroit	60000324
17	Extract air ISO Coarse > 75% (G4) filter stand for DV50 Adroit	60000346
17	Extract air ISO Coarse > 75% (G4) filter stand for DV80 Adroit	60000347
18	Filter set for DV50 Adroit	90000620
18	Filter set for DV80 Adroit	90000621
19	Duct plug for DV50 Adroit	60000348
19	Duct plug for DV80 Adroit	60000349
20	Cover panel 100 mm for DV50 Adroit	60000350
20	Cover panel 125 mm for DV80 Adroit	60000351
21	Condensation drain kit	60000250
22	Adroit Digital Controller (optional)	90000610
23	Adroit connection box	60000208
24	Adroit Humidity Transmitter (optional)	90000612
25	Adroit CO ₂ Transmitter (optional)	90000613

Adroit® DV50 DV80 (Integral CO₂ Sensor)

EXPLODED VIEW AND PARTS LIST

Extensive

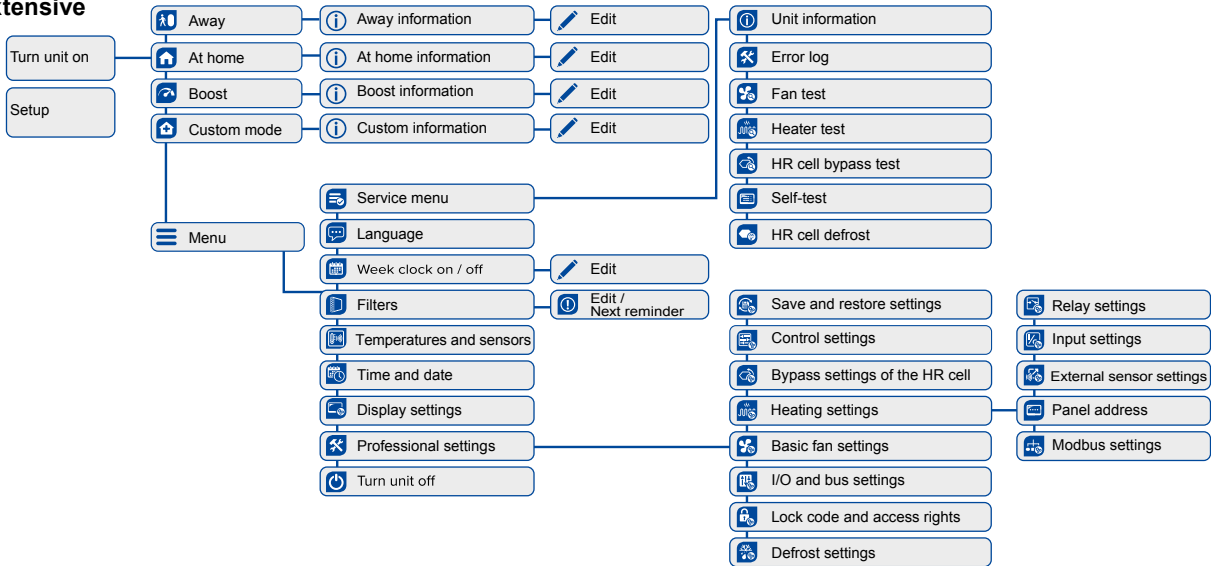

Normal

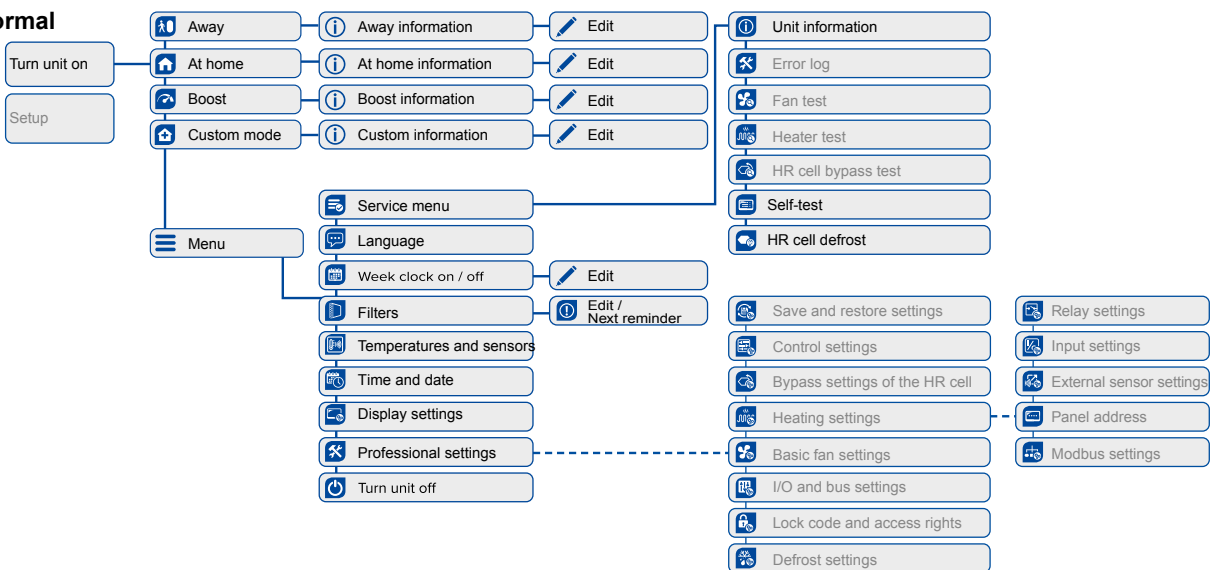

Adroit® DV50 DV80 (Integral CO₂ Sensor)

USER LEVEL DIAGRAM

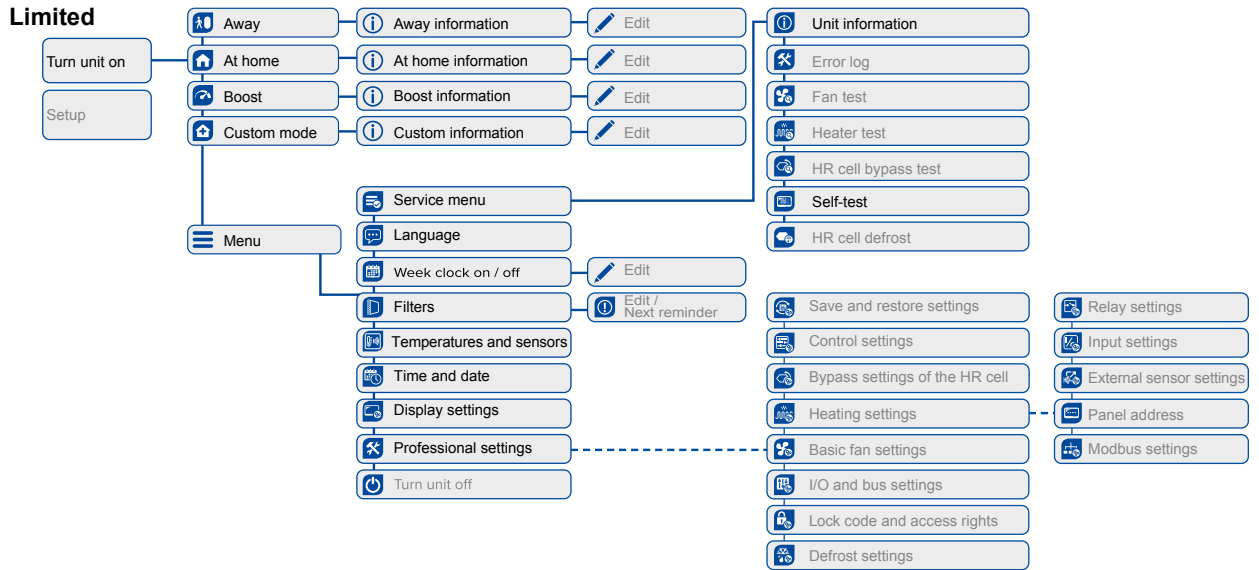

Adroit[®] DV50 DV80 (Integral CO₂ Sensor)



CE DECLARATION OF CONFORMITY

Airflow Developments Ltd, herewith declare that the air movement equipment designated below, on the basis of its design and construction in the form brought onto the market by us in accordance with the relevant safety and health requirements of the EC directive on Low Voltage.

Designation of Equipment: Mechanical Ventilation with Heat Recovery

Relevant EC council directives:

- 2014/35/EU** Low Voltage Directive
- 2014/30/EU** Electromagnetic Compatibility (EMC) Directive
- 2011/65/EU** Restriction on the use of hazardous substances (RoHS) Directive
- 2006/42/EU** Machinery Directive

Applied Harmonised standards:

- EN ISO 12100-1:2003+A1:2009** Safety of machinery. General principles for design. Risk assessment and risk reduction
- BS EN 61000-6-4:2007+A1:2011** Electromagnetic compatibility (EMC). Generic standards. Emission standard for industrial environments
- BS EN 60335-1:2012+A11:2014** Household and similar electrical appliances. Safety. General requirements
- BS EN ISO 13732-1:2008** Ergonomics of the thermal environment. Methods for the assessment of human responses to contact with surfaces. Hot surfaces
- BS EN ISO 3746:2010** Acoustics. Determination of sound power levels and sound energy levels of noise sources using sound pressure. Survey method using an enveloping measurement surface over a reflecting plane

Applied National Standards and Technical Specs. In Particular Basis of self-attestation:

- Quality Assurance** BS EN ISO 9001/2015 – Cert no – FM 00152
- Environmental Assurance** BE EN ISO 14001/2015 – Cert No – EMS 569454

Any alterations or modifications made to the equipment, without prior consultation with Airflow Developments Ltd, invalidates this declaration.

Name: Alan Siggins

Date: 10/06/2019
Position: Managing Director

Airflow Developments Limited
Aidelle House, Lancaster Road, Cressex Business Park
High Wycombe, Buckinghamshire. HP12 3QP, U.K.
T: +44 (0)1494 425252
E: info@airflow.com W: airflow.com

UKCA CERTIFICATE OF CONFORMITY



UKCA DECLARATION OF CONFORMITY

Airflow Developments Ltd, herewith declare that the air movement equipment designated below, on the basis of its design and construction in the form brought onto the market by us in accordance with the relevant safety and health requirements of the EC directive on Low Voltage.

Designation of Equipment: Mechanical Ventilation with Heat Recovery**Relevant EC council directives:**

2016 No.1101	The Electrical Equipment (Safety) Regulations 2016
2016 No.1091	The Electromagnetic Compatibility Regulations 2016
2012 No.3032	The Restriction of the Use of Certain Hazardous Substances in Electrical and Electronic Equipment Regulations 2012
2008 No.1597	The Supply of Machinery (Safety) Regulations 2008

Applied Harmonised standards:

EN 12100-1:2003+A1:2009	Safety of machinery. General principles for design. Risk assessment and risk reduction
BS 61000-6-4:2007+A1:2011	Electromagnetic compatibility (EMC). Generic standards. Emission standard for industrial environments
BS 60335-1:2012+A11:2014	Household and similar electrical appliances. Safety. General requirements
BS ISO 13732-1:2008	Ergonomics of the thermal environment. Methods for the assessment of human responses to contact with surfaces. Hot surfaces
BS ISO 3746:2010	Acoustics. Determination of sound power levels and sound energy levels of noise sources using sound pressure. Survey method using an enveloping measurement surface over a reflecting plane

Applied National Standards and Technical Specs. In Particular Basis of self-attestation:

Quality Assurance	BS ISO 9001/2015 – Cert no – FM 00152
Environmental Assurance	BS ISO 14001/2015 – Cert No – EMS 569454

Any alterations or modifications made to the equipment, without prior consultation with Airflow Developments Ltd, invalidates this declaration.

Name: Alan Siggins

Date: 10/06/2019

Position: Managing Director

Airflow Developments Limited
Aidelle House, Lancaster Road, Cressex Business Park
High Wycombe, Buckinghamshire. HP12 3QP, U.K.
T: +44 (0)1494 425252
E: info@airflow.com W: airflow.com

Adroit® DV50 DV80 (Integral CO₂ Sensor)

PRODUCT STATEMENT OF COMPLIANCE



Aidelle House, Lancaster Road, Cressex Business Park,
High Wycombe, Buckinghamshire,
HP12 3QP, United Kingdom

Product Security and Telecommunications Infrastructure Statement of Compliance

Airflow Developments Ltd, herewith declare that the air movement equipment designated below, on the basis of its design and construction in the form brought onto the market by us in accordance with the relevant requirements of the UK Product Security and Telecommunications Infrastructure (Product Security) regime.

Designation of Equipment: Airflow Ventilation Equipment

Series / Type:

- Adroit with Cloud Connectivity functionality Series
- Entro-V with Modbus Series
- Duplexvent AHU Units Series (Multi, Multi V, Multi N Rooftop, Multi Eco, Multi Eco V, Multi Eco N Rooftop, Rotary, Rotary N Rooftop, Flexi, DUPLEXhome PS, DUPLEXhome PT, DUPLEXbase PS, DUPLEXbase PT) with RD5 or RD6 Control System
- iCONsmart

Applied Legislations:

PSTI Act 2022 Part 1 of the Product Security and Telecommunications Infrastructure

Security Requirements for Relevant Connectable Products Regulations 2023 The Product Security and Telecommunications Infrastructure

The requirements are based on three of the original guidelines in the 2018 Code of Practice, and provisions in ETSI EN 303 645, on a statutory footing.

The minimum time that Airflow provides security updates for is 2 years from the date of installation/commissioning.

Information on how to report security issues related to the products listed above: please contact Airflow on the telephone number shown below and describe the security issues encountered.

Any alterations or modifications made to the equipment, without prior consultation with Airflow Developments Ltd, invalidates this declaration.

Signed:

Date: 28/03/2024

Name: Alan Siggins

Position: Managing Director

Telephone: (Int +44) (UK 0) 1494 525252; Fax: (Int +44) (UK 0) 1494 461073
E-mail: info@airflow.com; Website: www.airflow.com

Form No:- 080
Issue:- 002
Date Revised:- 09/06/2015



Adroit® DV50 DV80 (Integral CO₂ Sensor)

COMMISSIONING THE SYSTEM

The Building Regulations 2010, Statutory Instrument Part 9, paragraph 42, imposes a requirement that testing and reporting of mechanical ventilation performance is conducted in accordance with an approved procedure.

Compliance with this requirement by an assessed and registered "Competent Person" should follow a "Best Practice" process and adopt air flow measurement, Method A - The Unconditional Method - using a suitable UKAS certified measuring instrument. Generically referred to as a "Zero Pressure Air Flow Meter" or "Powered Flow Meter".

Further information on this method is detailed in NHBC Building Regulations Guidance Note G272a 10/13 and BSRIA "A Guide to Measuring Air Flow Rates" document BG46/2015

WARRANTY

Applicable to units installed and used within the United Kingdom. Airflow Developments Ltd guarantees the DV50 / 80 Adroit unit for 5 YEARS from date of purchase against faulty material or workmanship. Motors are only covered for 1 YEAR from date of purchase against faulty material or workmanship.

In the event of any defective parts being found, Airflow Developments Ltd reserve the right to repair, or at our discretion, replace without charge provided that the unit:

- Has been installed and used in accordance with the fitting and wiring instructions supplied with each unit.
- Has not been connected to an unsuitable electrical supply.
- Has not been subjected to misuse, neglect or damage.
- Has not been modified or repaired by any person not authorised by Airflow Developments Ltd.
- Has been installed in accordance with latest Building Regulations and IEEE wiring regulations by a recognised competent installer.

Airflow Developments Ltd shall not be liable for any loss, injury or other consequential damage, in the event of a failure of the equipment or arising from, or in connection with the equipment, excepting only that nothing in this condition shall be construed as to exclude or restrict liability or negligence.

This warranty does not in any way affect any statutory or other consumer rights.



Call: 01494 525252

Visit: airflow.com

80000997 - Issue 5 07/24



Airflow Developments Limited
Aidelle House, Lancaster Road,
Cressex Business Park,
High Wycombe, Buckinghamshire,
United Kingdom, HP12 3QP

E-mail: info@airflow.com
Telephone: +44 (0) 1494 525252

airflow.com

© Airflow Developments Limited. Airflow Developments Limited reserve the right, in the interests of continuous development, to alter specifications without prior notice. All orders are accepted subject to our conditions of sale which are available on request

